

COURSE CODE:	<i>PBS 302</i>
COURSE TITLE:	Basic Plant and Animal Breeding
NUMBER OF UNITS:	<i>3 Units</i>
COURSE DURATION:	<i>Four Hours per week</i>

COURSE DETAILS:

Course Coordinator:	Prof. D. K. Ojo B.Sc., M.Sc., Ph.D
Email:	dkojo58@gmail.com
Office Location:	Room 246, COLPLANT
Other Lecturers:	Prof. M. O. Ozoje , Dr. O. Olowofeso, Mr. E. O. Idehen and Mr. O. A. Oduwaye

COURSE CONTENT:

Definition of Plant and animal breeding: introduction, hybridization-inbreeding and outcrossing, hybrid and hybrid vigour, pureline, inbred line, manifestation of heterosis, consequences of inbreeding, selection and selection methods-mass and pureline selection; genetic basis of inbreeding in plants and animals; concept of heritability and genetic gain. Method of reproduction in plants; features that dictate mode of pollination in plants: crosses- main selection, recurrent selection, hybrid/synthetic varieties, meaning of protogamy, self-incompatibility, male sterility, floral devices, monoecy, dioecy; self-pollinating crops-meaning of autogamy, pureline breeding, bulk population breeding, pedigree breeding, backcross breeding, cleistogamy, apomixes, parthenocarpy. Breeding methods in plants – conventional; plant introduction, hybridization and selection, non-conventional: mutation, tissue culture and genetic engineering; polyploidy, aneuploids, euploids in plant breeding. Concept of disease and insect resistance - horizontal resistance, vertical resistance, tolerance, hypersensitivity, immunity; Breeding methods that can incorporate resistance in crop in plants – backcross breeding, pedigree breeding, genetic basis of backcross breeding, advantages/disadvantages of both.

COURSE REQUIREMENTS:

This students are expected to participate in all the course activities and have minimum of 75% attendance to be able to write the final examination.

READING LIST:

Jack Brown and Peter, D. S. Caligari. An introduction to Plant Breeding, Blackwell Publishing Ltd., 9600 Garsington Road, Oxford Ox4 2DQ, UK

LECTURE NOTES

Course Outline

- Character inheritance in plants and animals
- Changes in gene and gene structure
- Mutations, lethal traits and examples, pedigree analysis
- Cell, basic components of cell; cell cycle and cell division (Mitosis and Meiosis); Major differences between mitosis and meiosis and the significance of the two methods, gametogenesis (Spermatogenesis in male and Oogenesis in female)
- Alleles or allelomorphs (including simple and multiple alleles), symbols for alleles, Allelic relationships and common examples, multiple allelism with special emphasizes on coat colour in rabbit and the ABO blood type in humans, blood types, types acceptable for transfusion, determination of individual blood groups, medico-legal aspects of the ABO series including disputed parentage
- Genetics of sex (autosomes and sex chromosomes); classification of sex chromosomes in diploid organisms; sex differentiation and determination, sex ratio and assessment of sex ratio, Intersexes (Meaning, superfemales and metamales, etc); Two common sex chromosome anomalies in humans (Klinefelter and Turner syndromes and their characteristics), holandric genes, sex-linked or x-linked genes, sex-linked lethal, sex-limited genes, sex-influenced genes, examples of each.
- Definitions of plant and animal breeding; introduction, hybridization – inbreeding and outcrossing, hybrid and hybrid vigour, pureline, manifestation of heterosis, consequences of inbreeding, selection and selection methods – mass and pureline selection; Genetic basis of breeding in plants and animals; Concept of heritability and genetic gain
- Methods of reproduction; self pollination – meaning of autogamy, pureline breeding, bulk-pollination breeding, pedigree breeding, backcross breeding, cleistogamy, apomixes, parthenocarp, and cross pollination – main selection, recurrent selection, reciprocal recurrent selection, hybrid/synthetic varieties, meaning of protogamy, self-incompatibility, male sterility, floral devices, monocy, dioecy.
- Breeding methods in plants; Conventional – plant introduction, hybridization, selection, and Non-conventional – mutation, tissue culture, genetic engineering; Polyploid, aneuploids, euploids in plant breeding
- Concept of disease and insect resistance; horizontal resistance, vertical resistance, tolerance, hypersensitivity, immunity

LECTURE 1 AND 2

CHARACTER INHERITANCE: HERITABLE AND NON-HERITABLE TRAITS

Heritable traits are defined by their ability to be passed from one generation to the next in a predictable manner. Visible or otherwise measurable properties of heritable traits are called phenotypes, while the genetic factors responsible for creating the phenotypes are called genotypes. The most basic question to be asked about a trait is whether or not the observed variation in the character is influenced genes at all. It is important to note that this is not the same as asking whether or not genes play any role in the character development. Gene mediated developmental process lies at the basis of every character, but variation from individual to individual is not necessary the result of genetic variation. Thus, the possibility of speaking a language at all depends critically on the structures of the central nervous systems as well as the vocal cords, tongues, mouth and ears which depends in turn on the nature of the human genome. There is no environment in which cows for example, will ever speak. Although, the particular language human speaks defers or varies from nation to nations, this variation is totally non genetic. Therefore, the question of whether or not a trait is heritable is a question about the role that differences in genes play in the phenotypic differences between individuals or groups.

In principle, it is easy to determine whether any genetic variation influences the phenotypic variation among organisms for a particular trait. If genes are involved, then on the average the biological relatives should resemble each other more than the unrelated individuals do. This resemblance would be reflected as a positive correlations between parents and offspring between siblings. Parents who are larger than average would produce offspring that are larger than the average. The more seeds a plant produces the more seeds the siblings will produce also. Such correlations between relatives are however, evidence of genetic variations only if the relatives do not share common environment more that the non-relatives do. It is absolutely fundamental to distinguish between familiarity and heritability at this point. Traits are familiar if members of the same family share them for whatever reasons. Inherited traits vary widely in complexity. Some appear in principles to be relatively limited. For example, human eye colour, which may either be brown or blue. Whiles some apparently are more complex. e.g. the inheritance of the shape of the nose. Traits are heritable only if the similarity arises from shared genotypes. In experimental organisms, there's no problem in separating environmental from genetic similarities. The offspring of a cow producing milk at a high rate and the offspring of a cow producing at low rate can be raised together in the same environment to see whether despite the environmental similarity, each resembles its own parents. In natural populations, and especially in humans, this is difficult to do. Because of the nature of human societies, members of the same families not only share genes but also have similar environments. Thus the observation of simple familiarity of a trait is genetically un-interpretable. In general people who speak Yoruba have Yoruba parents and people who speak Ibo have Ibo parents, cross cultural activities over the years and the movement of people doing business at different locations in the country has demonstrated that this linguistic differences though familiar, are non genetic and non heritable. The distinction between heredity and familiarity are not always so obvious. For example, the disease pellagra (Vitamin deficiency disease) was ones thought to be heritable because it runs in families.

To determine whether a trait is heritable in human population, we must adopt studies that avoid the usual environmental similarities between biological relatives. Skin colour is clearly heritable as well as adult height but even in these traits also we have to be very careful. For example, the children of Japanese immigrants born in America are taller than there parents but shorter than the American average. So we might conclude that there are some influences of genetic differences. Yet there is also the effect of environmental cultural influences as second generation Japanese American are even taller than their American born parents. Personality traits, temperaments and cognitive performance (including IQ scores) and a whole variety of behaviours have been the subject of heritability studies in humans. Many showed familiarity. There is indeed a correlation between parents IQ and that of their children, but the correlation

does not distinguish familiarity from heritability. To make that distinction requires that the environmental correlations between parents and children be broken.

MUTATION

A gene mutation may be defined as a change in the code of information transmitted by the DNA molecule on the chromosome to the ribosomes in the cytoplasm of the cell by means of mRNA, which gives it instructions to build a specific protein. A change in this code means that a different protein is formed in the place of the one normally produced by instructions from the gene. For example, the change in the code sent by a gene could produce an entirely different protein such as sickle cell hemoglobin which differs from the normal adult hemoglobin in the kind and number of amino acids contained in the protein portion of the hemoglobin molecule. Mutation in its wide sense means every change in the heritable substance which is not due to segregation or recombination of previously existing genes. Mutation can occur in genes carried either on the autosomes or in those on the sex chromosomes. They may also occur in body cells or in the cells of the germinal epithelium of the testes and ovary. Reverse mutation may also occur. Most new mutations are harmful but some are desirable in their effects.

Gene mutations that occur in the body cells are not transmitted to the progeny of the individual where they occur. In order to be transmitted to the progeny they must occur in the sex cells, the sperm and the egg. The failure of a new mutation to occur in the progeny, especially if it were dominant, would suggest it to be in the body cells. An example is the black spot on the red coat of the Hereford cattle. Black is dominant to red so new mutation from single red gene to black would show in the individual. Black spots of this nature in Hereford have been noted from time to time, but their transmission or failure to be transmitted have not been studied. A new somatic cell mutation may occur in a cell early in embryonic life. Later cells descending from this parent cell in which the new mutation occurred could show the new mutation, providing it were dominant and could have effects different than observed in other cells in the surrounding tissues. An example is the appearance of brown spot within the otherwise blue eye in humans. **New** mutations which occur in the sex cells, sperm and egg, are transmitted from one generation to another. A new dominant mutation in the sex cells is followed by the transmission and appearance of the trait in the progeny of the individual where the first mutation occurred, providing the gene has a major effect on a trait and shows complete penetrance (or always shows up in the phenotype when present in the genotype). A new recessive mutation, however could occur and not appear in the descendants of the affected individual for many generations, or until two parents are mated which carry the same recessive mutation. Even then only about one of four offspring from such parents would be expected to show the mutation. A new mutation in a gene means that another allele at a particular locus on the chromosome has been produced which may affect the same trait in a different or alternative manner than the original gene. The new gene arising from the mutation reproduces itself exactly for succeeding generations as long as the individual carrying it survives and reproduces until a mutation of this gene occurs to produce still another gene in its place. A series of new mutation at the same locus is the explanation for the occurrence of several alleles in a multiple allelic series. e.g. The ABO blood type series in humans involving gene A for blood type A, B for blood type B and A for blood type O.

One of the most striking observations one can make in nature is the great variation among individuals in type, size, color, behavior, and etc. The genetic proportion of this variation is due to the accumulation of mutations within the species. If the genes could reproduce themselves exactly for generation after generation over a period of thousands of years without single mistake, members of a particular species would all be alike in colour, type and performance and would not be divided into distinct types and breeds. All variation that existed would be superficial environmental variations that could not be transmitted from parents to offspring.

Mutation can involve either a single gene, in which case it is called a point mutation or a whole chromosome or number of chromosomes or even their structures, in which case, it is called chromosomal mutation.

A point mutation occurs at a certain gene locus or a part thereof. A gene can also be inactivated as in the case when gene C which is responsible for the animal capacity to produce pigment in the skin, hair and feather mutate to c. Individuals which are homozygote for the latter gene becomes albinos. The gene c has however been altered in many different ways so that a series of multiple alleles has been build up. In rabbits, at least 5 different alleles are known which influences the intensity of pigmentation. In some cases one or more genes may be lost when a piece of chromosome breaks off during cell division. If the segment is large, it is more of a case of structural alteration of the chromosomes. In many cases, a point mutation is a reversible process and the new mutant gene is recessive to the earlier allele.

Chromosome mutation: Chromosomes can change in two basic ways- by alternation in structure or in numbers. Both types of alterations have consequences besides their immediate effects on chromosomes. For examples individual heterozygous for chromosomes with different structures often have lower fertility, and individuals with altered numbers of chromosomes may be unviable or sterile.

Structural changes: The four possible types of changes in chromosomal structures are duplications, deletions (or deficiencies), inversions and translocations. When breaks occur in chromosomes, any two broken chromosomal ends may reunite. Structural changes are often a consequence of a break occurring at one or more places on the chromosome in which the same broken ends do not reunite. In some cases rejoining takes place and if non of the gen loci is lost or damaged, the chromosome behaves normally after rejoining. Generally such chromosomal mutation occur infrequently, but some researchers have estimated that more than one in a thousand have gametes may be some type of chromosomal mutation. In the case however, that parts of the chromosome separate from each other (fragmentation) in which case several things can happen.

1. A Deletions can occur. If several breaks occur in a chromosome and a middle portion of the chromosome is lost and the outer parts rejoined, a deletion has taken place. Where an internal part of the chromosome is missing, is called an **interstitial deletion**. But if there is only one break and the homologue fails to rejoin, a **terminal deletion or deficiency** has occurred. In this case, the tip of the chromosome is usually lost in cell division because it does not have a centromere. In both cases, a portion of the chromosome with all its associated genes has been lost. When deletions are homozygous, they are often lethal, because essential genes are missing. Even when heterozygous, it can cause abnormal development. A well-known example in humans is the deletion of a substantial part of the short arm of chromosome 5 (5p), which when heterozygous causes the cri du chat (cry-of-the-cat) syndrome. In facts with this syndrome patients generally have a characteristic high-pitched, catlike cry as well as microcephaly (small heads) and severe mental retardation. They generally die in infancy or early childhood. In addition, deletion heterozygotes usually shown abnormal chromosomal pairing in meiosis. Because the normal chromosome does not have a homologous region to pair within a deletion loop is formed. This phenomenon may be sen in meiotic chromosomes or in the polytene chromosomes of *Drosophila* and a few other organisms. Several other characteristics are useful in identifying deletions. First, deletions, unlike other mutations, generally do not revert, or mutate back to the wild-type chromosome. Second, in deletion heterozygotes, recessive alleles on the normal chromosome are expressed because the deletion chromosome is missing the homologous region. Expression of recessive alleles in such cases, called **pseudodominance**, is useful in defining the length of

the deleted segment. For example, let us assume that genes B and c were deleted on one chromosome. If we have wild-type chromosomes with recessive mutants at different genes, these should be expressed if they are in the deleted region. Deletions can be used to map the sequence of the genes on the chromosome.

2. **Duplication:** When a chromosomal segment is represented twice, it is called a **duplication**. We can categorize duplication by the position and order of the duplicated region. First, the duplication may be adjacent to the original chromosomal region. When this occurs, the order may either be the same as the original order, called a **tandem duplication**, or the opposite order, called a **reverse duplication**. Secondly, the duplicate region may not be adjacent to the original segment, resulting in a **displaced duplication**. In this place the displaced duplication may still be on the same chromosome or it may be on another chromosome. Chromosomal duplication can occur during crossing-over process, when a segment lost from one chromosome is added to another chromosome. If a gamete with the duplicated chromosome unites with a normal gamete, the zygote formed would have those genes on the duplicated chromosome segment in triplicate. When an individual is heterozygous for a duplication and a normal chromosome, the duplicated regions does not have a homologous segment to pair with a meiosis I. As a result, a loop of the duplicated region may develop. In some cases, part of the chromosome may bend back and join. Individuals that are heterozygous or homozygous for a small duplicated segment may be viable, although they often exhibit some phenotypic effects noticeably due to gene duplication. If individuals are viable, there is a potential for further evolutionary changes in these extra genes. In fact it is thought that this happens with the different globin genes, the genes that code for the components of the protein hemoglobin. These genes may have descended from an ancestral gene that was duplicated and then the duplicate copies diverged in their function.
3. **Inversions:** Most of the homologous chromosomes in a population have genes in the same sequence. However, in some instances the sequence may differ on different chromosome, followed by an incorrect reunion. Alterations in the sequence of genes called **inversions**, may be of two different kinds relative to the position of the centromere. If the inverted segment does not contain the centromere, it is called **paracentric inversion** (Greek: para = next to), but if the version spans the centromere, it is called a **pericentric inversion** (Greek: peri = around). Individual heterozygous for an inversion can be recognized by the presence of inversion loops in meiotic pachytene chromosomes. These structures occur because of the affinity of the two homologues. The only way the two homologues can pair is if one twists on itself and makes a loop, while the other makes a loop without a twist. These loops can best be seen in the polytene chromosomes of organisms such as *Drosophila pseudoobscura*.
4. **Translocations:** A **translocation** is the movement (by breaking and rejoining) of a chromosomal segment from one chromosome to another, non-homologous chromosome. There are two types of translocations, an **interstitial translocation**, involving the one-way movement of a segment, and the more common **reciprocal translocation**, involving a two-way exchange of chromosomal segments. If two of the segments that join in a reciprocal translocation are large and the other two are small, the smaller translocated chromosomes are often lost. In this case, the number of chromosomes is reduced by the chromosomal exchange. Obviously, translocations can change both the size of chromosomes and the position of the centromere. Even though chromosomal segments have been exchanged between chromosomes in a reciprocal translocation, the affinity of the homologous regions results in pairing during meiosis I. If nearly equal parts of chromosomes are exchanged or not exchanged, the

paired chromosomes in a translocation heterozygote have a cross appearance in metaphase I. During anaphase I, two major types of segregation occur: one in which adjacent centromeres goes to the same pole (adjacent I.) and two, the alternate centromere goes to the same poles. When alternate centromeres go to the same pole, the chromosomes often form a figure eight shape in early anaphase I. The products of this event, which is known as **alternate segregation**, are balanced so that each gamete has a full complement of chromosomes; either two untranslocated or two balanced translocated. On the other hand, when adjacent centromeres segregate together, **adjacent segregation**, the chromosomes appear as a ring at metaphase I. When this occurs, the products are unbalanced, resulting in duplications and deletions in the gametes. Some plants, and also a few animals, have a series of reciprocal translocations, so that chromosomal heterozygotes also have nearly all the chromosomes associated in a large ring (or rings) in meiosis. However, at anaphase these chromosomes may undergo an orderly alternate segregation, producing only zygotes with a balance chromosomal complement. Although translocations can resulting in normal chromosomes, they can also cause several human diseases. For example, about 5% of individuals with **Down syndrome** have one parent who is heterozygous for a translocation. In this instance, chromosome 14 is translocation onto chromosome 21. Half of the time, the heterozygote produces either the normal set or a balanced translocated set of chromosomes, making the progeny either normal or translocation heterokaryotypes, respectively. The other half of the time, unbalanced chromosomes are produced, either a 14 without the translocated 21 segment or a translocated 14 without the translocated 21 segment or a translocated 14 with the attached 21 plus a normal 21. In the first case, offspring get only one 21 chromosome, a lethal chromosomal component. In the second instance, three 21 chromosomes are received, resulting in Down syndrome. Overall then, approximately one-third of the live births from some a translocation heterokaryotype can be expected to have Down syndrome. In actual fact, the proportion is less than this, primarily because some Down individuals do not survive gestation. Note that this cause of Down syndrome has implications for genetic counseling. First, Down syndrome could recur in children of a translocation heterokaryotype, whereas normally Down syndrome does not recur in sibs. Second, half of the phenotypically normal sibs of Down individuals are themselves translocation heterokaryotypes, and therefore could produced Down progeny.

Changes in chromosomal number

The numbers of chromosomes may vary in two basic ways: **euploid** variants, in which the number of chromosomal sets differ, and **aneuploid** variants, in which the number of a particular chromosome is not diploid. As one might expect, changes in chromosome number, either euploid or aneuploid, generally have a greater effect on survival than do changes in chromosome structure. In fact, in humans, more than half of the spontaneous abortions that occur in the first three months of pregnancy involve fetuses with aneuploidy, polyploidy, or other large chromosomal aberrations.

Polyploidy (Euploidy Variation): Organisms with three or more complete sets of chromosomes are called **polyploids**. If we let the haploid number of chromosomes be x , then organisms with three chromosomes sets have $3x$ chromosomes and are called triploids; those with $4x$ chromosomes are tetraploids; those with $6x$ chromosomes are hexaploids; and so on. However, for organisms that are regularly polyploidy, such as many plants, x usually refers to the number of chromosomes in a set and n to the number in a gamete. Thus, in a hexaploid organism with 60 chromosomes, $6x = 2n = 60$, so that $x = 10$ and $n = 30$. Polyploidy is relatively common in plants but rare in most animals, occurring only in certain beetles, earthworms, salamanders, fishes, and a few other organisms. On the other hand, nearly half of all flowering plants are

polyploids, as are many important crops. For example, potatoes are tetraploid ($4x = 48$), bread wheat is hexaploid ($6x = 42$), and strawberries are octoploid ($8x = 56$). Polyploidy is less frequent in animals than in plants for several reasons. First, sex determination is often more sensitive to polyploidy in animals than in plants. Second, plants can often self-fertilize, so a single new polyploidy plant with an even number of chromosomal sets (tetraploid, hexaploid, etc.) can still reproduce. Finally, plants generally hybridize more easily with other related species, an important attribute, because the different sets of chromosomes in a polyploid often have different origins. We can distinguish two types of polyploids: those that receive all their chromosomal sets from the same species, **autopolyploids**, and those that obtain their chromosomal sets from different species, **allopolyploids**. For example, if any unreduced or diploid pollen grain from a diploid organism fertilizes a diploid egg of the same species, the offspring are **autotetraploids**, or AAAA, where A indicates a complete chromosomal set, **genome**, of type A. On the other hand, if diploid pollen of one species fertilizes a diploid egg of another, related species, the offspring are **allotetraploids**. Or AABB, where B indicates a genome from the second species. All the chromosomal sets in an autopolyploid are homologous, just as they are in a diploid. But in allopolyploids, the different chromosomal sets generally vary somewhat and are called **homeologous** or partially homologous.

Triploid organisms are usually **autopolyploids** (AAA) that result from fertilization involving a haploid and a diploid gamete. They are normally sterile because the probability of producing balanced gametes is quite low. For example, most bananas are triploids; they produced unbalanced gametes, and as a result, are seedless (they are propagated by cuttings). **Allopolyploids**: Most naturally occurring polyploids are allopolyploids, and they may result in a new species. For example, the bread wheat *Triticum aestivum* is an allohexaploid with 42 chromosomes. By examining wild related species, it appears that bread wheat is descended from three different diploid ancestors, each of which contributed two sets of chromosomes (in this case designated as AABBDD). Pairing occurs only between the homologous sets, so that meiosis is normal and results in balanced gametes of $n = 21$.

Aneuploidy: The cause of aneuploidy is non-disjunction; that is, two homologous chromosomes fail to separate properly during meiosis or mitosis. Non-disjunction in meiosis itself is thought to result from improper pairing of homologous chromosomes on opposite sides of the metaphase plane, or from failure of chiasma formation. As a result, both chromosomes may go to the same pole, leaving one daughter cell with an extra chromosome and the other daughter cell with no chromosome. When these gametes are fertilized by a normal gamete, they either have an extra chromosome, $2n + 1$, termed **trisomy**, or are missing a chromosome, $2n - 1$, termed **monosomy**. Non-disjunction is most common in meiosis I, but it can occur in meiosis II as well. Non-disjunction can also take place in mitosis, resulting in mosaics for normal and aneuploid cells. Other combinations of extra chromosomes are possible, the most important being a tetrasomic with $2n + 2$ chromosomes and a nullisomic with $2n - 2$ chromosomes, in which no copies of a particular homologue exist. Trisomics are known in many different species. They are viable in many plants, but are less frequently viable in animals. For example, among the aneuploids that have been most thoroughly studied are those in the Jimson weed, or thorn apple. A series of *Datura* mutants with strange properties, turned out to be trisomics for different chromosomes. In fact, a trisomic for each of the twelve different chromosomes was found, and each had a particular phenotype. The effects on the appearance of the seed capsule were quite different for trisomies of the different chromosomes, suggesting that different chromosomes have different hereditary effects on this trait. Trisomics have been investigated in crop plants such as corn, rice and wheat in an effort to identify the chromosomes carrying different genes. Crosses involving plants with trisomic chromosomes give unusual segregation ratios. For example, if a homozygous dominant trisomy, AAA (The A symbol again indicates a dominant allele), is crossed to a recessive diploid, aa, half the progeny are trisomic AAa half are diploid Aa. When the trisomic progeny are backcrossed to aa individuals, approximately one-sixth of the progeny are recessive aa. If the gene had been on a chromosome that was not trisomic, the F1 would be Aa, and one-half, not one-sixth, of the backcross progeny would be homozygous recessive (aa). In animals, trisomics and other aneuploid chromosomal complements are more unusual. From analysis of the chromosomal constitution of

spontaneous abortions in humans, it appears that nearly all monosomics and many trisomics are fetal lethals. However, several trisomics that sometimes come to full term compose a substantial part of congenitally abnormal births. One of the most common is Down syndrome, trisomy of chromosome 21, with a frequency of one in seven hundred live births. Down syndrome, first described nearly 150 years ago, is generally characterized by mental retardation, distinctive palm prints, and a common facial appearance. In general, mortality is higher than normal: the average life span is the middle tens to the forties, depending upon the country, but some individuals live much longer. People with Down syndrome generally have a positive disposition, and some are able to be partially independent. The chromosomal basis of Down syndrome was first discovered in 1959, shortly after the correct human diploid number was determined. Detailed banding of human chromosomes has shown that Down syndrome actually results from a trisomy of the smallest chromosome, which is actually chromosome 22. However, because Down syndrome is known so prevalently as trisomy 21, this association was not changed, and the smallest chromosome is still called chromosome 21. The current nomenclature to indicate an individual with trisomy 21 is $47 + 21$, in which 47 indicates the total number of chromosomes and +21 indicates that there are three, rather than two, copies of chromosome 21. The other autosomal trisomies are much rarer, mostly because they are not viable as fetuses.

Nondisjunction of the sex chromosomes in human is the source of several conditions. Four common viable, but abnormal chromosomal types XO, XXX, XXY and XYY, are produced through nondisjunction. The symbol O here indicates the lack of a sex chromosome in a gamete or zygote.

Klinefelter syndrome, XXX (or 47, XXY), occurs fairly frequently and generally results in a relatively mild abnormality. These individuals are sterile males with some female characteristics. Individuals with **Turner syndrome** (XO or 45, X) are sterile females, short in stature, with some neck webbing. The frequency of XYY (or 47, XXY) is about one per one thousand males, but such males do not appear to have any congenital problems. At one point, it was suggested that XYY individuals had criminal tendencies, but further study indicates minimal correlation with behavior, if any. The frequency of XYY (or 47, XYY) individuals in prisons is significantly higher than that of the general populations; however, less than 5% of all XYY individuals are actually institutionalized. Abnormal chromosome numbers in a fetus can be diagnosed using **amniocentesis**. In this procedure, a sample of fluid is withdrawn from the amniotic sac with a needle. The fetal cells contained in this fluid are cultured for two or three weeks. Dividing cells are then stained, and the chromosomes are examined and counted to check for chromosomal abnormalities. The X chromosome is different from the other chromosomes in that only one is active in given cell. Normal males have only one X, which is active in all cells. In normal females, only one X is active in a given cell and the other X is heterochromatinized, or mostly inactive. The mostly inactivated X forms a structure called a **Barr body** that can be identified in a cell. Therefore, normal males and XO individuals have no Barr bodies; normal females and XXY individuals have one: XXX individuals have two: and so on. In other words, by counting the number of Barr bodies in a cell, chromosomal abnormalities involving the X chromosome can be determined. The incidence of Down syndrome, and to some extent, other aneuploidies, increases with the age of the mother. The incidence of Down for mothers of age forty-five is nearly 50-fold that for teenage mothers. Although the exact mechanism for this increase is unknown, it appears to be related to the difference in gametogenesis between females and males. In females, oocytes are formed before birth and held in a resting stage (actually prophase of meiosis 1) until just before ovulation. In older mothers, an oocyte may remain at this stage for over forty years, during which time it may be affected by environmental factors that may cause a non-disjunction.

Causes of Mutations

Mutation can either be spontaneous or induced. In **spontaneous mutation**, mutagens are not involved. Base pairs changes and chromosomal aberrations can occur spontaneously, e.g. Adenine molecule can exist in two forms called tautomers. In its more stable configuration, it form two hydrogen bond with thymine in the DNA. If it however, undergoes a tautomeric shift such that a hydrogen atom

moves from the 6-ammonia group to the 5N position, then hydrogen bonding with cytosine can occur at the A-T position. If the A-C pairing occur while DNA is replicating, then at the ensuing round of replication, one of the daughter DNA helical will have a G-C pair instead of an A-T pair at that position.

Induced mutation: Mutation can be induced either physical or chemical means. Irradiation is an example of physical mutagens with X-ray, gamma-ray, ultraviolet light being the most commonly use mutagens. Their mode of action is through breakage of chromosomes which may result in chromosomal rearrangement. On the other hand, chemical mutagens can act in a variety of ways depending on the properties of the chemical and its reactions with the bases of the DNA. Some examples of chemical mutagens are 5-bromouracil, a base analogue whose structure resembles the structure of one of the bases in the DNA. In its **keto** state, it pairs with guanine. Mutation can therefore be induced by 5-bu in two ways. The first involves the incorporation of the normal 5-bu into DNA during replication. If it shifts to its enol state during the next round of replication, then the result will be a transition mutation from A-T to G-C.

Other chemical mutagens are **2-minopurine** which is also a base analogue that can bond with both thymine and cytosine in its two forms. **Nitrus acid NA** a deaminating agent is another chemical mutagen. It removes the ammonia group (NH₂) from the bases altering their base pairing abilities and hence inducing mutation. When adenine is treated with NA, it changes to hypoxanthine which can pair with cytosine thus resulting in A-T to G-C mutation. **Hydroxylamine NH₂OH** induces mutation in a specific way in that it can react with cytosine hydroxylating it so that it can only pair with adenine thereby inducing a G-C to A-T pairing. **Acridine** treatment results in the addition or deletion of one base pair in the DNA.

LETHALS AND GENETIC ABNORMALITIES

Death of an organism may occur at any stage of development – immediately following fertilization, during embryonic differentiation, at parturition, or postnatally. Death may be due to a variety of causes, such as injury, diseases, malnutrition, and harmful irradiations such as X-rays and gamma rays. Any cause of death is termed lethal effects. Among the many causes of death are gene changes which are incompatible with development or survival. These genes are known as lethal (deadly) genes. They are deleterious genes with drastic effects causing the death of the young during pregnancy or at time of birth. Some other genes which are deleterious to the organisms may not be lethal, provided that environmental factors especially are favorable. If not, they however, can cause the death of the young after birth or sometimes later in life. These genes are called semi-lethal or sub-lethal genes. Still other genes do not cause death, but definitely reduce viability or vigor. These genes are referred to as nonlethal or detrimental genes.

A lethal gene may have its effect any time from the formation of the gamete until birth or shortly afterward. In a strain of horse, a sex-linked recessive lethal gene has been reported that kills approximately half of the male offspring of carrier females, so there are approximately twice as many females as males at birth. Dwarfism in Herefords resulting from the mating of Comprest with Comprest is an example of a gene with semi-lethal effect. The dwarfs are born alive, as a general rule, but most invariably die before they are one year of age.

Most detrimental and lethal genes are either recessive or partially dominant and must be present in the homozygous state to have their full effect. In some instances, the partial dominant genes affect the heterozygous individuals so that they are intermediate in phenotype between the normal and the homozygous recessives. Some lethal genes however, are sex-linked. Examples of sex linked lethals are the hemophilia and Duchene muscular dystrophy genes. A slight scratch or accident injury which would not be serious in normal person often results in fatal bleeding for the affected hemophilia individual. Duchene muscular dystrophy is a disease in which the affected individual though apparently normal in early childhood exhibit progressive wasting away of the muscles resulting in confinement to wheel chair about the age of twelve and death in the teen years. Like hemophilia, it is due to a recessive sex-linked gene.

Detrimental recessive genes are generally present at low frequencies in a population, and in many cases, only inbreeding, line breeding or chance will cause their occurrence in the homozygous state.

Typically, a lethal or other abnormality would first come to the attention of the breeder when one or more defective individuals appear in the herd or flock. There are no absolute rules for determining whether the abnormality is hereditary or environmental in origin, whether it is due to some combination of hereditary and environmental influences or whether it is merely an accident or development.

However, the following would indicate hereditary based defects.

1. If previous studies on a scale large enough to be conclusive has shown a hereditary basis for a phenotypically similar condition in the same species or breed.
2. If the condition appears only in some breeding groups or families.
3. If it occurred in herds where there had been inbreeding. Inbreeding does not create abnormalities, but since most abnormalities are recessive, it tends to bring them to light as a result of increased homozygosity resulting from inbreeding.
4. If it occurred in more than one season when rations and environment differed.

The following indicates an environmentally base defect.

1. If it occurred when ration of dam was known to have been deficient or when she had been under stress.
2. If it had previously been reliably reported as due to ration or environment.
3. If it did not recur after rations or environment were changed.

In strict sense every abnormality are the product of heredity and environment. If the gene or genes conditioning an abnormality are uniformly expressed over a range of environments which includes the 'normal', we see only the genetic effects and think of it as genetic.

Recessive Defects with Some Expression in Heterozygote

Most lethals and abnormalities are recessive in inheritance, whether due to one or several genes. The death or culling of affected individuals usually keeps the frequency of the gene or genes at low levels and in equilibrium with mutation rate. A few cases are known in which recessive-ness is not complete, and the heterozygotes or carriers have characteristics which make them more favored or desired by breeders than the homozygote normal. A classical example of this is the Dexter breed of cattle. Cattle of this type are always heterozygous for a semi dominant gene which when homozygous produces a lethal acondroplasia (bulldog calves). Dexters themselves show the effects of the gene by shortness of leg. When inter-mated, Dexter produces $\frac{1}{4}$ long legged individuals known as kerrys, $\frac{1}{2}$ short legged Dexter and $\frac{1}{4}$ bulldog calves. Apparently, the hereditary situation is as follows:

Preference of British breeders for the short legged Dexters has resulted in the development of bred carrying lethal gene at a frequency of 0.5. Since the heterozygous individuals are easily identified. It would be an easy matter for breeders to cull them of they so desired. The Dexter type can be propagated without the production of lethals by avoiding the inter-mating of Dexter. Kerry X Dexter matings give 50% each of kerry and Dexter types. A more intriguing situation occurred in a Swedish dairy breed. A type of infertility characterized by gonadal hypoplasia was found to be highly hereditary but not a clear cut case of a single gene pair of gene action. Although it was not demonstrated beyond reasonable doubt, evidence indicated that unilaterally affected cows, on average, produced milk with higher than average fat percentage and were favored in selection. The gene or genes responsible for the condition attained such frequency in the breed that bilateral gonadal hypoplasia (with resultant sterility) reach a level constituting a serious problem to the breed. International selection against the condition subsequently reduced the frequency markedly.

In the mid years of the twentieth century, a type of dwarfism characterized by small size, high mortality, bulging foreheads, undershot jaws, difficult breathing, a tendency to bloat, and poor coordination reached a frequency in at least two breeds of cattle in the U.S. high enough to constitute an

economic problem. The common name 'snorter' dwarf was applied to these animals. Initially the condition appeared to be inherited as a simple recessive. Although definite proof is lacking, the apparent increase in frequency strongly suggested that the gene was not completely recessive, but has some effect in the heterozygous condition making animals shorter-bodied and lower-set.

A partial deficiency of uridine monophosphate (UMP) synthase was also discovered in Holstein cattle. The enzyme is responsible for the conversion of orotic acid to UMP, the precursor of all other pyrimidine nucleotides. Affected animals have half the normal activity for this enzyme when heterozygous for the condition. Homozygous recessive genotypes apparently are lethal in utero. Advances in molecular genetics have permitted the identification of carriers through DNA probes. More often however breeders have to use pedigree information and progeny testing method for reducing the frequency of such conditions.

Semilethal Recessive Related to Economically Desirable Traits.

Fortunately, few characters of this kind are known. In several breeds of swine in both the U.S. and Europe, a pork quality problem became apparent in the mid fifties and sixties in type selected for muscularity and thin back fat. It is known as pale, soft and exudative pork (PSE). In the carcasses of the affected individuals the lean tissue is light in color and lack firmness; fluid may seep from cut surfaces. A second condition highly associated with PSE but not completely linked, is the so called pork stress syndrome (PSS) in which the affected pigs are unable to withstand even short periods of strenuous physical exercise and may die quickly when subjected to such stress. In some cases susceptible animals may live to market weight and even reproductive ages if not subjected to undue stress. However, death rate may be high, particularly during marketing, and for this reason PSS can be a highly important economic problem. A test involving exposure of pigs to standard level of halothane anesthetic for a prescribed period was devised to identify stress susceptible animals. In this test stress susceptible animals develop muscular rigidity, while normal pigs are unaffected. PSS has been found to be inherited as a simple recessive gene trait. Interestingly it is related to certain blood groups. The most dramatic example of the relationship of PSS to economic traits was reported from Switzerland, where two lines of pigs were selected from the same base population. One for superiority and the other for inferiority on an index based on daily gain and back fat thickness. After six generations, 42 percent of the superior line was halothane susceptible whereas none of the inferior line was affected.

Detrimental Genes

Most livestock breeds have standard colors or color patterns which serves as breed trademarks. Most of these are unrelated to productivity, but a few are of economic worth. For example, white udders in beef cows lead to 'snow burn' if cows calve in spring before snow is gone. Again, pigment in and around the eyes of white-faced cattle reduces the incidence of eye and eyelid cancers. In hot areas with intense sunlight, light coat colors in cattle reflect more heat and thus are an aid in maintaining normal body temperature.

Most basic color variations are inherited in a fairly simple fashion, and in many cases maintenance of the breed trademark constitutes no special problem. Shades of color have been a concern in several breeds of both cattle and swine. In spite of the fact that, there is no known relationship between shade of color and productivity, fads for certain shades have sometime developed.

Experiments with small laboratory animals, indicates that in some instances gene affecting coat color also affect the vigor of the individual. One of the first of these effects was found in a certain strain of yellow mice. When yellow mice were mated, they produced approximately two yellow to one non yellow offspring rather than the 3:1 ratio expected if yellow were dominant and non-yellow recessive and yellow mice were heterozygous. It was found that homozygous yellow individuals died at an early stage of gestation, and the surviving yellow animals were heterozygous. Thus, a lethal gene was related to the homozygous yellow color. Platinum foxes are also known to be heterozygous, because they produced two

platinum to one silver offspring when mated. The homozygous platinum individual apparently die before birth as a general rule.

Some lethal coat colors have also been reported in farm animals. Sheep of certain gray breed, when mated together, produce progeny of which one-fourths are gray. This indicates that black is recessive. A large proportion of the gray lambs possess as abnormal abomasums as well as other defects of the digestive tract, that causes death within a few months after birth. A recessive gene for gray coat color in Collie dogs is accompanied by an increase susceptibility to infections and death at a young age. Blue-eyed white cats are usually deaf.

In most breed of sheep and cattle, the presence or absence of horns depends fairly upon simple genetic patterns. The size and shape of horns are apparently modified by many pairs of genes, each with minor effects, In most European breeds, the presence or absence of horn usually behaves as if under the control of a single pair of allelic factors with dominant allele resulting in the absence of horns or polledness. In most fine – wool sheep, the presence or absence of horns depends upon a single pair of alleles with heterozygote being horned in males. Females of all genotypes are polled or have a slight amount of horny growth known as knobs. The polled gene is related in some way in breeds of this type to cryptorchidism, a defect in which testicles are retained in the abdominal cavity rather than descended in to the scrotum. Whether the cryptorchidism is due to a pleiotropic effect of the same gene or to a closely linked gene is not known with certainty. A few normal ram have been progeny tested at high levels of probability and are apparently homozygous for the polled gene. This would indicate either: 1. Close linkage which has been broken off. 2. Presences of modifying genes which prevented the expression of cryptorchidism even though this is a normal pleiotropic effect of the gene.

Genetic Abnormalities Affected by Environment Variations.

The expression of abnormalities in laboratory animals and plants varies within the range of normal environments. The bar-eye condition in the fruit flies. (*Drosophilla melanogaster*) is one of the best known of these. The normal compound eye of this insect has many subunit or facets – usually 800 or more. In bar-eye individuals the number is much reduced, but the reduction is much larger at high rearing temperatures than low. Expressive of abnormality of this type is said to exhibit genetic-environmental interactions. In swine, scrotal hernia has a hereditary base, but its incidence is also influenced by a maternal effect. The nature of the effect is not known, but it appears to have differential effects on different genotypes.

Several defects in farm animals are conditioned partially by hereditary variations of quantitative nature and partially by environmental factors. The best known of these is cancer eye in cattle. It occurs more frequently in Herefords than in other breeds. Although, it occurs in most geographical locations; within this breed it is more frequent in location with high average annual hours of sunshine. Latitude and altitude are also related to incidence, probably are a result of differences in the ultraviolet component of sunlight. It is usually an affliction of older cattle. Its incidence increases, and it occur at younger sage in cattle maintained on high level of nutrition. Hereditary variations affect the age of cancer development as well as occurrence or nonoccurrence. Hereford cattle with pigmented eyelids and corneoscleral areas are less susceptible than white eyed types. Selection against defects of this type is difficult because they are expressed more frequently at advanced age. A sire may have left many offspring before it is discovered that his daughters have an unusually high susceptibility to a condition such as cancer eye. Selection for pigmented eye should be an effective indirect method of selecting against cancer-eye susceptibility.

Strategy for Control of Genetic Defects

The action to be taken if a lethal or genetic abnormality is discovered in a herd depends upon the type of herd and the seriousness of the abnormality. In a commercial herd, the only action usually necessary is to cull the sire or sires which produced the defective offspring and replace them with unrelated males. For most traits the frequency is so low that the probability of obtaining new sires which also carry the defective gene. The probability of acquiring replacement sires which do not carry the deleterious gene

or gene can be increased by knowledge of the pedigree lines to avoid. Corrective measures may need to be more drastic in seed-stock herds since the owner has an obligation to provide stocks which will perform well for future customers.

For seed-stock herds, the following should be considered as possible measures for elimination of the defect or for reducing its frequency.

1. Cull all sires which have produced defective offspring.
2. Replace the herd sires culled with animals whose pedigrees indicate there should be only minimal probabilities of the new sires being heterozygous for the defects.
3. Remove all females which have produced defective offspring from the seed-stock herd itself. They may be placed in an auxiliary herd and used to progeny – test future herd sires to determine whether they are heterozygous for the gene(s) responsible for the defect.
4. Cull other close relatives of affected individuals including normal offspring of sires and dams which have produced defective individuals.
5. If the affected individuals are viable and fertile, retain them for progeny – testing prospective breeding animals.
6. Progeny – test prospective herd sires before using them extensively in the herd.

Penetrance and Expressivity

A gene does *not* determine a phenotype by acting alone; it does so only in conjunction with other genes and with the environment. In the examples of gene interactions, the genetic basis of the dependence of one gene on another has been worked out from clear genetic ratios. However, in other situations, where the phenotype ascribed to a gene is known to be dependent on other factors but the precise inheritance of those factors has not been established, the terms *penetrance* and *expressivity* may be useful in describing the situation.

Penetrance is defined as the percentage of individuals, with a given genotype which exhibit the phenotype associated with that genotype. For example, an organism may have a particular genotype but may not express the phenotype normally associated with that genotype because of modifiers, epistatic genes or suppressors in the rest of the genome or because of modifying effect of the environment. Penetrance can be used to measure such an effect when it is not known which of these types of modification underlies the effect. On the other hand, expressivity describes the extent to which a given genotype is expressed phenotypically in an individual. Again, the lack of full expression may be due to the allelic constitution of the rest of the genome or to environmental factors.

Human pedigree analysis and predictions in genetic counseling can often be thwarted by the phenomena of variable penetrance and expressivity. For example, if a disease-causing allele is not fully penetrant (as often is the case), it is difficult to give a clean genetic bill of health to any individual in a disease pedigree (for example, individual R in Figure below).

On the other hand, pedigree analysis can sometimes identify individuals who do not express but almost certainly do have a disease genotype (for example, individual Q in the figure below).

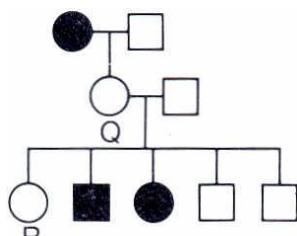

Figure: Lack of penetrance illustrated by a pedigree for a dominant allele. Individual Q must have the allele (because it was passed on to her progeny), but it was not expressed in her phenotype. An individual such as R cannot be sure that his or her genotype lacks the allele.

Phenocopies

An environmentally caused trait may mimic a genetic trait, for instance a heat shock delivered to *Drosophila* pupae may cause a variety of defects which mimic those caused by mutations in genes affecting wing or leg development. In humans, the drug thalidomide taken during pregnancy caused phenocopies of the rare genetic disease [phocomelia](#), children were born with severe limb defects.

Pedigree Analysis

A family history, known as a pedigree, is an orderly diagram of a family's relevant genetic features, extending back to at least both sets of grandparents and preferably through as many more generations as possible. From systematic pedigree analysis in the light of Mendel's laws, geneticists can tell if a trait is determined by alternative alleles of a single gene and whether a single-gene trait is dominant or recessive. A pedigree analysis is the interpretation of these data that allows a better understanding of the transmission of genes within the family. *Pedigrees* are a convention for keeping track of genetic traits used to infer genotype. Pedigree analysis in its broadest sense is the process of making inferences about a particular pedigree-or set of pedigrees-on the basis of partial information. The information available may be of three types: the genealogical structure (how the members of the pedigree are related to each other), the phenotypes (the "data" collected on each pedigree member), and the mode of transmission (the genetic-or other-mechanism underlying the distribution of phenotypes over the members of the pedigree). Pedigree analysis is then used to make inferences about the information that is missing. *Pedigrees* are the human equivalent of test crosses. Usually, at least one member of the family has a genetic [disease](#), and by examining the pedigree, clues to the mode of inheritance of the disorder and the potential risk to other family members can be obtained. A member of a family who first comes to the attention of a geneticist is called the **propositus**. Usually the phenotype of the propositus is exceptional in some way. Many pairs of contrasting human phenotypes are determined by pairs of alleles inherited in exactly the same manner shown by Mendel's peas. Pedigree analysis can reveal such inheritance patterns, but the clues in the pedigree have to be interpreted differently depending on whether one of the contrasting phenotypes is a rare disorder or whether both phenotypes of a pair are part of normal variation.

Traits associated with dominant, recessive, sex linked, etc. alleles and loci display characteristic patterns in *pedigrees* just as they do when following traits in any organism by any means (i.e., in addition to historical).

Pedigree analysis can also allow estimation of [gene](#) penetrance and gene expressivity. Pedigree is initiated by using a symbol to represent the proband or individual seeking counselling. Immediate family members (parents, siblings, spouse, children) are added next, followed by aunts, uncles, cousins, grandparents, and others in the proper orientation. Males are indicated as squares and females as circles. The [square](#) or [circle](#) is filled in for any affected individuals to reflect their disease status. When two people marry or have children together, a single line is drawn between them. A vertical line descends from this

marriage line and then connects to another horizontal line, the sibship line. Short vertical lines descend from the sibship line, one for each of the children of this union. All members of one generation are shown adjacent to one another. There are special symbols to denote, identical twins (a single line from the sibship line that bifurcates for each twin), fraternal twins (an inverted V drops from the sibship line), divorce and remarriage (cross hatches on the marriage line to show discontinuity between the [divorced](#) partners and a second marriage line to the new partner), and so on (see fig 1).

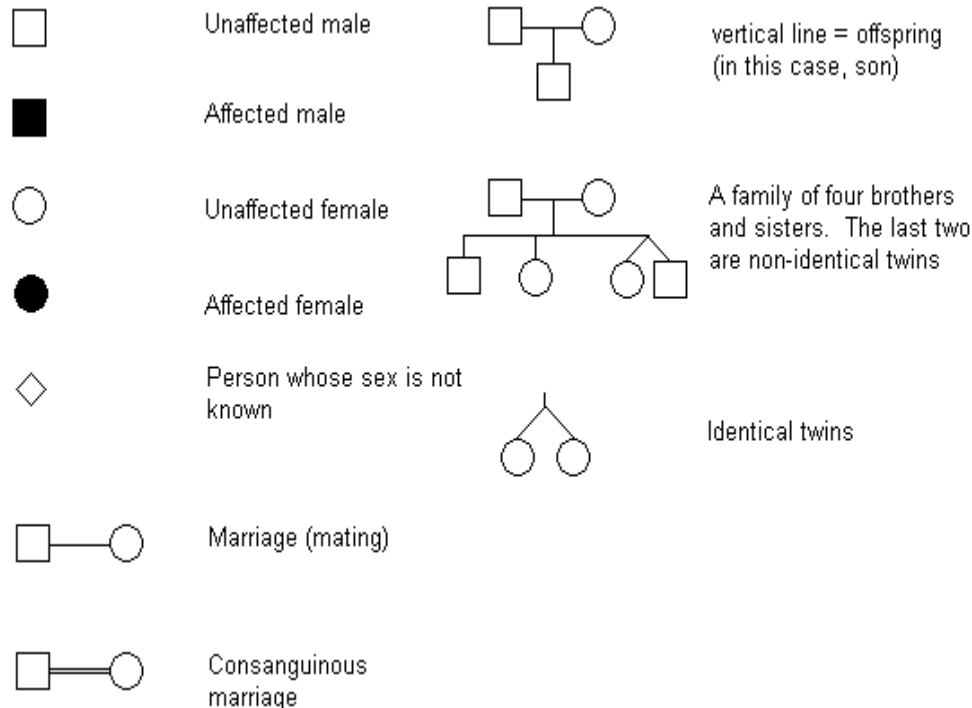

Fig. 1: Symbols used to draw pedigrees.

Generations are numbered from the top of the pedigree in uppercase Roman numerals, I, II, III etc. Individuals in each generation are numbered from the left in arab numbers as subscripts, III₁, III₂, III₃ etc.

Each generation is labelled at the left with a Roman numeral beginning with the first generation. The members of each generation are consecutively numbered left to right with Arabic numbers, always starting each generation with one. In this way, each person can be specifically identified. For example, the second person in the first generation would be individual I-2, and the sixth person in the fourth generation would be IV-6.

Once the family members are properly arranged, important medical facts can be added. Proper interpretation of the pedigree is dependent upon obtaining accurate information about each individual in a pedigree. The first step in pedigree analysis is to observe the number and relationships of all individuals who express the same or similar clinical features. From this, it should be possible to determine if the disorder is dominant or recessive, autosomal or X-linked by looking for the typical patterns of inheritance. For example, an autosomal disease can usually be distinguished by seeing male-to-male transmission of the [mutation](#), but since males pass only the [Y chromosome](#) to their sons, there should never be father to son transmission of an X-linked gene.

Males will be most commonly affected in an X-linked disease, whereas males and females should be equally affected in autosomal disorders. In general, a dominant disease will be seen in approximately half of the individuals in each generation, but recessives occur very rarely. If the mutation is in the mitochondrial [genome](#), affected mothers will pass the trait to all of their children, but none of the offspring of an affected male should have the disease.

Most human genes are inherited in a Mendelian manner. We are usually unaware of their existence unless a variant form is present in the population which causes an abnormal (or at least different) phenotype. We can follow the inheritance of the abnormal phenotype and deduce whether the variant allele is dominant or recessive.

Autosomal dominant

A dominant condition is transmitted in unbroken descent from each generation to the next. Most matings will be of the form $M/m \times m/m$, i.e. heterozygote to homozygous recessive. We would therefore

and thus

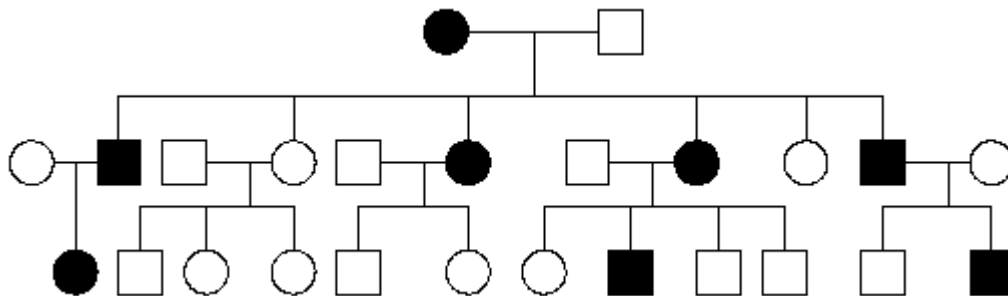

Examples of autosomal dominant conditions include [Tuberous sclerosis](#), [neurofibromatosis](#) and many other cancer causing mutations such as [retinoblastoma](#)

Autosomal recessive

A recessive trait will only manifest itself when homozygous. If it is a severe condition it will be unlikely that homozygotes will live to reproduce and thus most occurrences of the condition will be in matings between two heterozygotes (or carriers). An autosomal recessive condition may be transmitted through a long line of carriers before, by ill chance two carriers mate. Then there will be a $\frac{1}{4}$ chance that any child will be affected. The pedigree will therefore often only have one 'sibship' with affected members.

a) A 'typical' autosomal recessive pedigree, and b) an autosomal pedigree with inbreeding:

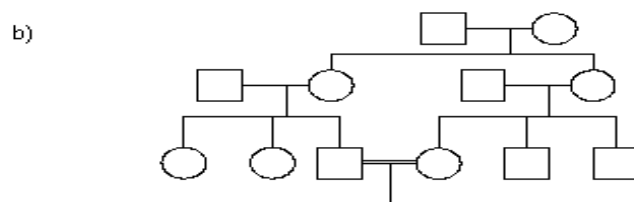
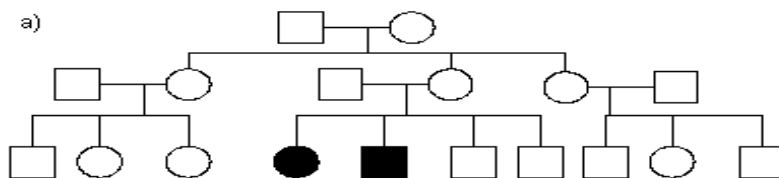

If the parents are related to each other, perhaps by being cousins, there is an increased risk that any gene present in a child may have two alleles identical by descent. The degree of risk that both alleles of a pair in a person are descended from the same recent common ancestor is the degree of inbreeding of the person. Let us examine b) in the figure above. Considering any child of a first cousin mating, we can trace through the pedigree the chance that the other allele is the same by common descent. Let us consider any child of generation IV, any gene which came from the father, III₃ had a half chance of having come from grandmother II₂, a further half chance of being also present in her sister, grandmother II₄ a further half a chance of having been passed to mother III₄ and finally a half chance of being transmitted into the same child we started from. A total risk of $\frac{1}{2} \times \frac{1}{2} \times \frac{1}{2} = 1/16$

This figure, which can be thought of as either the chance that both maternal and paternal alleles at one locus are identical by descent or the proportion of all the individual's genes that are homozygous because of identity by common descent, is known as the coefficient of inbreeding and is usually given the symbol F.

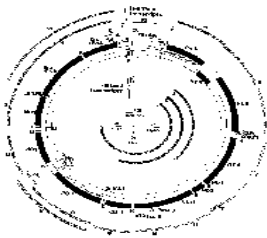

Mitochondrial inheritance

The human mitochondrion has a small circular genome of 16,569 bp which is remarkably crowded. It is inherited only through the egg, sperm mitochondria never contribute to the zygote population of mitochondria. There are relatively few human genetic diseases caused by mitochondrial mutations but, because of their maternal transmission, they have a very distinctive pattern of inheritance.

A mitochondrial inheritance pedigree

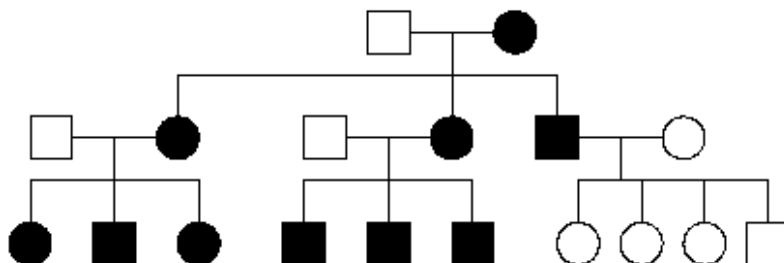

All the children of an affected female but none of the children of an affected male will inherit the disease.

Once the inheritance pattern of the disorder is determined, the status of family members in the pedigree can be evaluated. By carefully observing the position of affected individuals, mutation carriers may be identified. From this data, the risk of carrier status for other family members or the chance that a couple may have an affected child can be estimated.

Pedigrees are also maintained for many animals, though the purpose of pedigree analysis is somewhat different. The data contained in the pedigree are generally utilized to select individuals with specific characters for breeding purposes. Animals with unfavourable traits are eliminated from consideration so that the next generation will include individuals with more of the preferable traits. For each species, the characters of choice will vary. In the thoroughbred world, pedigree analysis tries to combine speed with stamina and a will to win that will yield winning racehorses. For cows, sheep, and pigs, such characteristics as high milk production, higher muscle content, or better wool are desirable. Even some plants have pedigrees as researchers strive to find drought and pest resistant species with high crop yields.

Questions

1. The following pedigree could be the result either of the segregation of an autosomal dominant condition or of an autosomal recessive. In the former case what is the risk for individual III₆ of having a child affected with this condition. In the latter case, who in the pedigree is an obligate carrier? And which other members of the pedigree are at risk of being carriers. Write down their risks.

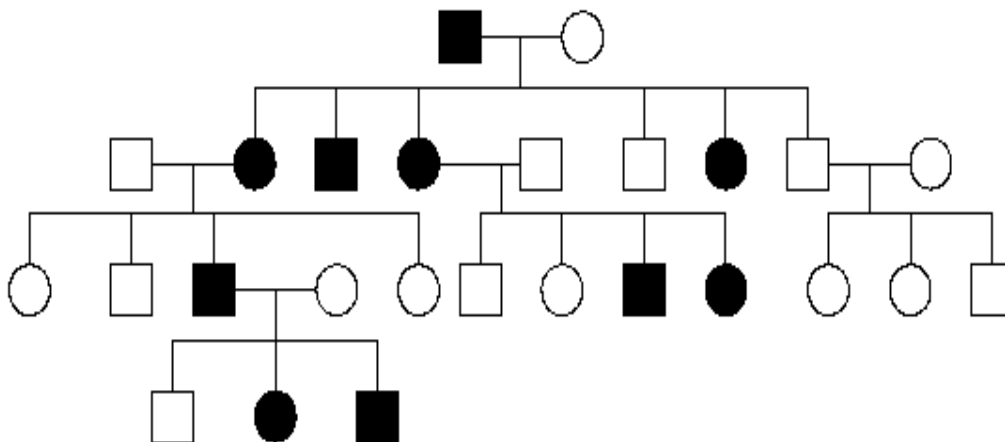

LECTURE 3 AND 4

CELL

The cell is the basic unit of every living organism. All forms of life are made up of cells. A cell has an important similarity in all organisms. The cell of all organisms normally consists of the **two** most important parts. These two most important parts of the cell are the:

- i. Nuclear portion (or the nucleus)
- ii. Non-nuclear portion (or the cytoplasm)

Some organisms have distinct nucleus, whereas some do not have well defined nucleus. Those organisms with well defined nucleus are called **eukaryotes**, while those without distinct nucleus are called the **prokaryotes** and these include bacteria and blue green algae. Examples of single-celled eukaryotic organisms include the **yeast (*Saccharomyces cerevisiae*)**, the **ciliate (*Paramecium aurelia*)**, **fungi**. For the higher eukaryotes, examples include fruit fly, corn, mouse and human being.

Apart from the two major components of cells (i.e. the nucleus and cytoplasm), there are also the organelles. The organelles divide the cell into compartments.

General components of the cell

1. The nucleus: is at the core of every cell, usually the eukaryotics. The nucleus is the house of genetic material called DNA. The DNA can organize into units called the **gene**, which direct metabolic activity of cells. The genes can be organized into threadlike structure called the **chromosome**, which serves as vehicle for transmission of genetic information. Apart from the chromosomes contained in the nucleus, **nucleolus** is also found in the nucleus. The nucleolus is a large body that contains **RNA and proteins** and it represents the site of synthesis and storage of the cell ribosomes. The chromosomes in the nucleus contain chromosomal material called **chromatin**. Chromatin is a complex of **DNA and protein** that associate during non-divisional phases of cell.

In the nucleus, synthesis and assembly of ribosomal RNA (rRNA) occur. In prokaryotes, there are no nuclear envelope and membraneous organelle. The genetic material, (DNA) is compacted into an area called **nucleoid region**. Generally, the prokaryotic cells, do not have a distinct nucleus, but do contain genes that specify rRNA molecules.

2. The cytoplasm: This is the non-nuclear portion of the cell. Cytoplasm contains soluble **enzyme, free ribosome, colloidal material called cytosol**, which surrounds and encompasses the cellular organelles. **Cytoplasm also contains cytoskeletal fibres**, which maintains the cell shape and anchors the various organelles.

3. The cell organelles: The cell organelles are many and include:

a. Endoplasmic reticulum (ER): It may be smooth in which case it serves as the site for synthesis of fatty acids and phospholipids. It may be rough when studded or bound with ribosomes. The function of both smooth and rough ER is to increase the surface area available for biochemical synthesis. ER is also called **ergastoplasm**.

b. Ribosomes; the ribosomes are the structures that are involved in protein synthesis. It serves as the sites for the translation of genetic information contained in rRNA into proteins in the *central dogma of molecular genetics*.

c. Mitochondria: This is found in both plant and animal cells. It is called the power house of the living cell. There is a large generation of adenosine triphosphate (an energy-rich molecule) in the mitochondria. The chloroplast is found in plants, similar to mitochondria, it contains green pigment (chlorophyll) and is essential for photosynthesis. The mitochondria are the site for oxidative phases of cell respiration. Chloroplasts and mitochondria possess chromosomes of their own. **Energy transformation occurs in mitochondria.**

d. Golgi bodies or apparatus is popularly known as dictyosomes. This organelle is important for the synthesis of many proteins that are secreted from the cell.

e. The centrosome and centrioles are involved in cell division from generation to generation for continual inheritance. The centrioles are found within the centrosomes which are associated with the organization of spindle fibres.

Apart from these major organelles, there are also some minor organelles that can be found on the cell.

Both plant and animal cells are almost alike. As seen under the light microscope, plant cell contain cell wall, cell membrane, cytoplasm (clear fluid), the dense fluid or the centre which is the nucleus, which is also surrounded by nuclear membrane. Typical animal cell is like plant cell except for the absence of **cell wall**.

In active dividing cell, there is always threadlike structures called chromosomes and this is found within the nucleus. The cytoplasm of the cell is highly organized system of membranes where cellular functions such as protein synthesis (on ribosomes), carbohydrate synthesis (in chloroplast) and energy transformation (in mitochondria) take place.

THE CELL CYCLE

The cell cycle can be regarded as the series of sequence or stages of cell growth and DNA replication that occur during the interphase stage. In eukaryotes, the DNA synthesis leading to chromosomes replication takes place throughout the interphase and ceases only during the brief period of mitotic nuclear and cell division.

The cell cycle involves some stages designated as:

G _I	=	growth phase I or Gap I
S-phase	=	synthesis period
G _{II}	=	growth phase II or Gap II
and M	=	mitosis
Note that, G	=	gap, and S = Synthesis

During G_I-phase (this is the period of pre-DNA synthesis), but essentially there is no DNA replication or synthesis. During G_I, cells only engage in growth and metabolic activity but not in chromosome replication. It last for some minutes. There are two periods during interphase before and after the S-phase. These periods or phases are called Gap I and Gap II respectively. During Gap I and II (i.e. G_I and G_{II}) i.e before and after S-phase, there is no DNA synthesis. DNA synthesis or replication only occurs during a discrete interval of the interphase and this period is known as S-phase or S-period. It must be noted that the S-period occur between G_I and G_{II} phases. The G_{II} period is ordinarily followed by mitosis (M), and the sequence G_I → S → G_{II} → M, followed by another G_I, is known as **cell cycle**.

During G_I, S, G_{II} phases, there are cell growth and metabolic activity, followed by DNA replication, and cell growth and metabolic activity, respectively and there is differentiation of cell. At the end of G_{II}-phase, the volume of the cell has doubled, DNA has been replicated and mitosis is initiated. When nutrients become scarce, the cell shift into a stationary phase (G₀) in which cellular metabolism essentially shifts into a holding pattern until nutrients are replenished.

After G_{II}, mitosis is initiated and are sub-divided into phases in the order of: **Prophase, metaphase, anaphase and telophase**, respectively.

CELL DIVISION

Cell division means the production of at least two cells from a pre-existing one. The division will consequently result in the division of nuclear material and the cytoplasm. Cell division partitions the cytoplasm and nucleus of a pre-existing cell into two daughter cells in such a way that the two daughter cells are more or less identical.

KARYOKINESIS AND CYTOKINESIS

Division of the nucleus is called **karyokinesis**, while the division of the cytoplasm is called **cytokinesis**. Usually, cytokinesis often followed karyokinesis. The process of cytokinesis usually occurs in the telophase stage of mitosis.

MITOSIS AND MEIOSIS

Two types of nuclear division that are characteristics of most plant and animal cells are mitosis and meiosis. Mitosis is regularly associated with nuclear division of vegetative or somatic cells. Meiosis occurs in conjunction with formation of reproductive cells (either gametes or meiospores) in sexually reproducing species.

MITOSIS

The mechanism by which new cells are formed and by which these cells retain identical chromosomes numbers and hereditary factors before and after every cell division is referred to as **mitosis**. Mitosis is responsible for the production of body cell. Mitosis is a form of cell division in which the mother cells posses the diploid number of chromosome (2n) and produce daughter possessing the same chromosome complement.

Mitosis is a smoothly continuous process, but is divided arbitrarily into several stages or phases for convenience reference. As a process, mitosis is remarkably similar in all, but relatively minor details in both plants and animals.

The stages of mitosis are: (i) Interphase, (ii) Prophase, (iii) Metaphase, (iv) Telophase, (v) Anaphase.

The interphase stage is as described for cell cycle above. i.e. during interphase there is non-dividing nucleus and there is G_1 -S- G_{II} -phases (i.e. before and after S-phase) (i.e. G_1 and G_{II} -phase) there is cell growth and metabolic activity, but no chromosome replication except in the S-phase.

Prophase

As the G_{II} of interphase gives way to prophase and the following occur:

- Chromosome progressively shortens and thickens to form individually recognizable structures arranged randomly in the nucleus.
- Two sister chromatids of each chromosome are formed and closely aligned and coiled on themselves. The two parts of the chromosome are called the chromatids. The sister chromatids are similar genetically.
- The two sister chromatids are held together in a specialized or condensed region called the centromere. The centromere contain granules called kinetochores and one for each sister chromatid.
- During prophase, nucleolus gradually disappears in most organisms
- During prophase, there is degeneration and disappearance of the nuclear membrane
- As prophase progresses, spindle fibres begins to form or have been laid down. These are football-shaped mitotic apparatus between the centrioles which are now at opposite ends of the cell. At this stage, the nucleus and nuclear membrane are no longer visible and sister chromatids now appeared as part of each chromosome.

Prometaphase

This is the period of chromosome movement to the equatorial plane.

Metaphase

- Is the period of time in which centromeres of chromosomes occupy the plane of the equator of the mitotic apparatus.
- At metaphase, sister chromatids are still held together by connecting fibres at the centromere regions.
- During metaphase, chromosomes are shortest and thickest.

Anaphase

- During anaphase, sister chromatids of each double chromosomal structure separate from each other and migrate to opposite ends of the cell
- Centromeric region must divide into two and once this occurs, the chromatids are called daughter chromosome.

Telophase

Is the final stage of mitosis

- Telophase begins with the arrival of daughter chromosomes at the spindle poles.
- Telophase terminates by the reorganization of two new nuclei and their entry into G_1 stage of interphase.
- New nuclear membranes are constructed from endoplasmic reticulum or from remnants of original materials

- Mitotic apparatus disappears
- Nucleoli are reformed and chromosomes resume their long, slender, extended form as their coils relax.
- Replication of chromosome materials also occurs during telophase.

Significance/importance of mitosis

1. In mitosis, the chromosomal material is distributed in equal quantity to two daughter cells in a precise manner.
2. In mitosis, there exists a process in which equal distribution of structures called chromosomes can be carried through cell generation after cell generation.

DURATION OF MITOSIS

The duration of mitosis most especially prophase, metaphase, anaphase and telophase varies from species to species.

In onion, the total duration for PMAT = 84 minutes

In pea, total time for (PMAT) = 110 minutes

In bean = 155 minutes

In fowl = 34 – 52 minutes

In mouse = 59 minutes

In grasshopper = 181 minutes

MEIOSIS

Is the process by which chromosomes numbers in organisms are halved in the process of formation of **sex cells or gametes**. Meiosis normally occurs in organs that produce sex cells or gametes **e.g testes and ovaries in mammals**. Meiosis is a form of nuclear division. It consists of two successive divisions each with its own prophase, metaphase, anaphase and telophase, respectively.

Meiosis results in four daughters nuclei instead of two as in mitosis. The nuclear products of a meiotic division have a haploid number of chromosomes as opposed to the two sets (diploid) of the parent nucleus; the nuclear products are genetically unlike the original diploid nucleus and often genetically unlike each other.

The **two meiotic divisions are the first meiotic division and the second meiotic division**. The first meiotic division is also known as the reductional division because it results in the halving of the chromosomal complement from $2N$ to N . It is divided into some phases. Similarly, the second meiotic division is also divided into some phases.

KEY FEATURES OF MEIOSIS

1. The net effect of meiosis is to reduce a cell's chromosome number by half usually from an initial $2N$ to N
2. Each haploid product (N) of meiosis is allotted one complete set of chromosomes information pertaining to that species.
3. It is the stage in eukaryotic development in which new gene combinations are generated. These gene combination come about in two ways:
 - a. Maternally and paternally derived homologous chromosomes that coexist in a $2N$ organism are distributed among the organism's haploid meiotic combinations.
 - b. Maternally and paternally derived homologous chromosomes frequently take part in genetic exchange during meiotic prophase.

STAGES OF MEIOSIS

Meiosis is a very lengthy process. It is longer than the mitosis. A complete cycle of meiosis takes days or weeks rather than hours.

The two successive division of meiosis are:

1. First meiotic division or reductional division
2. Second meiotic division

The first meiotic division includes:

- a. Prophase I
- b. Metaphase I
- c. Anaphase I, and
- d. Telophase I

Similarly, the second meiotic division is also divided into:

Prophase II

Metaphase II

Anaphase II

Telophase I

FIRST MEIOTIC DIVISION OR REDUCTIONAL DIVISION

Prophase I: prophase I is the most complex and in animals, it takes about 5 days to complete. Prophase I is broken down into five sub-stages called: *Leptonema, Zygonema, Pachynema, Diplonema and Diakinesis (LZPDD)*

The adjectives that can also be used to describe the first four stages are leptotene, zygotene, pachytene and diplotene. These stages are defined arbitrarily and they flow from one to another.

Leptonema = Leptotene

In the leptonema stage, the following occur:

- Chromatin begins to condense
- Chromosome begins to become visible or recognizable as fine thread.
- Chromosome shortens and thickens progressively.

Zygotenema = Zygotene

Chromosomes continue to shorten and thicken

- There is initial alignment of chromosomes and this result in rough pairing called synapsis.

Pachynema = Pachytene

- Coiling, shortening and thickening of chromosomes continues
- There is intimate pairing of chromosomes called **synapsis**
- Synapsed homologs are clearly seen to be composed of two chromatids. (i.e pairing of homologue is completed)
- There is formation of chiasmata (i.e a point at which non-sister chromatids have undergone genetic exchange through the process of crossing over)
- Physical homologues exchanges that result in chromosomal crossing over occur during pachynema.

Diplonema = Diplotene

In diplotema stage, there is

- Separation of homologues (except at points where chiasmata occur) is initiated
- Chromosomes continue to contract.
- Nucleolus begins to disappear

Diakinesis

This is the last stage of prophase I. In diakinesis stage, the following occur

- Chromosome reach maximum contraction
- Synapsed homologs become well spaced out in the nucleus.
- Chiasmata gradually terminalize i.e. they appear to move toward the ends of the arm and slips off. This process is called **TERMINALIZATION**
- The chromosomes continue to shortening
- Nucleolus disappear or break down
- Nuclear membrane degenerate
- Spindle fibre is formed.

METAPHASE I

- This is characterized by spindle formation
- Synapsed homologue chromosome arrived at the equator of the spindle
- Each tetrad interacts with spindle fibres, facilitating movement to the metaphase plate.

ANAPHASE I

There is separation event or disjunction during anaphase I. This means that one double chromosome of each pair separate and moving to each pole, thereby completing the process of terminalization.

- Occasionally error in meiosis occurs and separation is not achieved. The term non-disjunction is used to describe such an error.
- Anaphase I of meiosis is characterized by separation of homologous entire chromosomes
- Arrival of chromosome at the poles of spindle signal end of anaphase I.

TELOPHASE I

- This commences with the arrival of chromosomes at the poles
- Chromosomes may persist for a while in a condensed state.
- Nucleolus and nuclear membrane begin to reconstitute.
- Cytokinesis (division of cytoplasm) may occur

Meiotic telophase is shorter than the corresponding stage in mitosis

SECOND MEIOTIC DIVISION

This also involve four other phases called Prophase II, Metaphase II, Anaphase II and Telophase II.

PROPHASE II

- Chromosomes become visible as threadlike in cell, become condensed and thickened

METAPHASE II

- Chromosomes appear shorter than prophase II
- Each chromosome appear double and the two chromatids are joined by centromeres
- Centromere connecting pairs of chromatids move to a metaphase plate.

ANAPHASE II

The centromere connecting the chromatids after moving to the metaphase plate then divides into two halves and move to opposite poles at anaphase.

TELOPHASE II

Telophase II reveals one member of each pair of homologous chromosome present at each pole. At the completion of telophase II, four haploid cells or **TETRAD** have derived from each original diploid cell and each haploid cell now returns to an interphase state. Each chromosome is then referred to as **MONAD**.

Significance of meiosis

- i. There is the formation of four monoploid (haploid) nuclei from a single diploid nuclei in two successive divisions, thus balancing off the doubling of chromosome number that result from syngamy (the union of gametes or sex cells to form a zygote).
- ii. In animals, meiosis lead to the formation of gametes, while in plants, haploid spores are produced which in turn lead to formation of haploid gametes.
- iii. Through meiosis, there is maintenance of constant amount of genetic information between generations
- iv. There is also extensive genetic variation as a result of meiosis

Differences between mitosis and meiosis

S/No.	Mitosis	Meiosis
1	Mitotic division leads to the production of daughter cells whose chromosome numbers are identical with that of the parent cell.	Meiosis results in the production of four daughter nuclei instead of two in mitosis. The nuclear products of meiosis are genetically unlike the original diploid nuclei and genetically unlike each other.
2	Mitosis is also known as equational division	Meiotic division are divided into two successive divisions. First meiotic division is called reductional division because it results in halving the chromosome complement from 2N to N
3	Mitotic stage are very simple	Meiotic stages are very complex and continuous process
4	There is no pairing or synapsed chromosomes in mitosis	Homologous chromosome paired in meiosis (i.e there is synapsis of chromosomes)
5	There is no crossing over event in mitosis	The haploid cells produced during meiosis are not identical to parent cell because of crossing over.
6	Separation of duplicated centromeres occur in mitosis	There is absence of this separation in meiosis. Until second meiotic division

GAMETOGENESIS

The formation of gametes is known as gametogenesis. In male it is called **spermatogenesis**, while in female, it is called **Oogenesis**. The production of male gamete (sperm) is called spermatogenesis, while the formation of the ovum (ova) is called Oogenesis in female.

Spermatogenesis occurs in the testes of male animal whereas Oogenesis occur in the ovaries of the female animal.

SPERMATOGENESIS

Occur in the testes of male animal. It begins with growth of an undifferentiated diploid germ cell called **spermatogonium**. This cell undergoes enlargement to become primary spermatocyte which is

still diploid. The primary spermatocyte has undergone first meiotic division to give secondary **spermatocytes** (haploid). The secondary spermatocytes then undergo the second meiotic division and each of this cell produces two **haploid spermatids**.

The spermatids go through a series of developmental changes called spermiogenesis and become highly specialized motile sperm or spermatozoa. All sperms produced during spermatogenesis received equal amount of genetic material and cytoplasm.

Spermatogenesis may be continuous or occur periodically in mature male animals. Animals that reproduce year round produce sperm continuously, while those whose breeding period is confined to a particular season produce sperm only during that time.

OOGENESIS

In animal, Oogenesis which is the formation of ovum (ova) or eggs occur in the ovaries, which is the female reproductive organ. The process begin with the growth of undifferentiated diploid cell called oogonium located in the nucleus. Surrounding the nucleus that accommodates the oogonium is the cytoplasm. The oogonium undergone enlargement to produce the primary oocyte which is still diploid. The diploid primary oocyte undergo first meiotic division to produce haploid secondary oocyte and the first polar body which is also haploid but the polar body do not have cytoplasm.

The secondary oocyte undergone second meiotic division to produce the haploid ootid and second polar body which is also haploid and has no cytoplasm. The ootid then differentiates to mature ovum. Unlike spermatogenesis, oogenesis may not be continuous. (**N.B:** Note that the first and second polar bodies do not have cytoplasm).

LECTURE 5 AND 6

SINGLE GENE INHERITANCE

Basic terminologies

1. **Phenotype:** a distinctive trait possessed by an organism or the appearance or discernible character of an individual is called a phenotype. The trait may be visible to eye or it may require special tests for its identification. The phenotype is the result of gene products brought to expression in a given environment.
2. **Genotype:** the genetic make-up of an individual is called the genotype. For example, if two gametes say A₁ and A₂, the offspring that will result will have genotype A₁A₂ or if egg produces A and sperm produces A, the zygote that will result will have genotype AA
i.e. A x A AA

Genotype may be classified into (i) homozygous genotype and (ii) heterozygous genotype

HOMOZYGOUS GENOTYPE

The union of gametes carrying identical alleles produces a homozygous genotype. A homozygote produces only one kind of gamete. For example, if the two uniting gametes from egg and sperm are A and A. The zygote resulting from this will be a homozygous genotype

i.e.

Egg

Sperm

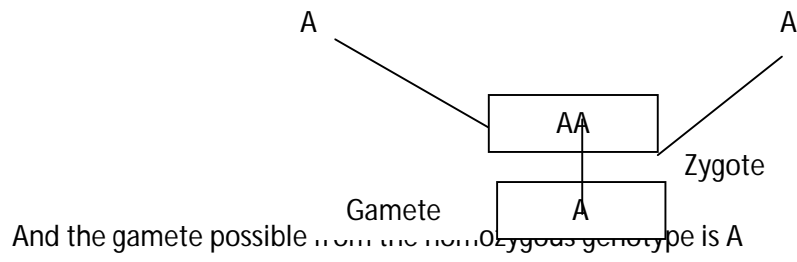

HETEROZYGOUS GENOTYPE

The union of gametes carrying different alleles produces a heterozygous genotype, and different gametes are produced by a heterozygote.

Example

Uniting gametes, say egg (A) and sperm (a) i.e

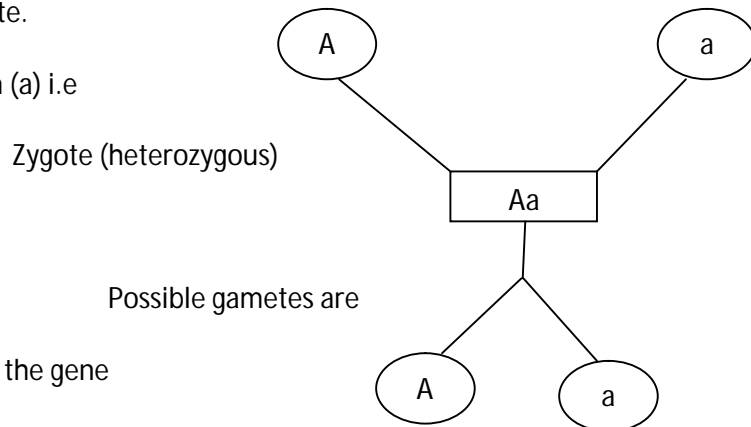

3. Gene: the basic unit of inheritance is the gene

4. Alleles: the alternative form of the gene is called the allele. There are two common types of alleles and these are:

- (i) Wild-type or Normal allele
- (ii) Mutant allele or abnormal trait

The wild-type can also be designated as normal alleles. The allele that occurs most frequently in a population is usually referred to as wild type or normal and this allele is usually dominant. As a result of mutation i.e. a sudden change in gene function or conformation, there is alternation or loss of the specific wild type function and new allele are formed. The new allele arising as a result of mutation of the wild (normal) type is called the **mutant allele**.

SYMBOLS FOR ALLELES

To discriminate between wild type and mutant alleles, a system is often used. In this system, the initial letter of the name of the mutant trait is recessive, the lower case letter(s) is used. If it is dominant, the upper case letter is used. The contrasting wild type trait is denoted by the same letter, but with "+" as a superscript.

For example, ebony is a recessive body colour mutation in fruit fly (*Drosophila melanogaster*). The normal wild type body is gray using the above system, ebony by the symbol *e*, while gray is denoted *e⁺*.

With ebony mutation as an example, the responsible locus may be occupied by either wild type allele (*e⁺*) or mutant allele (*e*). A diploid fly may thus exhibit three possible genotypes as follows:

- e⁺/e⁺*: Gray homozygote (i.e. wild type allele),
- e⁺/e*: gray heterozygotes (wild type),
- e/e*: ebony homozygote (mutant allele).

The "slash" is used to indicate that the two allele designations represent the same locus on two homologous chromosomes. Also, if a dominant such as wrinkled (*Wr*), the three possible designations would be:

- Wr⁺/Wr⁺*
- Wr⁺/Wr* and
- Wr/Wr*

The advantage of this system is that further abbreviation may be used when convenient. The wild type allele can simply be denoted by the + symbol using **ebony** as an example under consideration in a cross.

The three designations genotypes can also be written as:

- + / +*: gray homozygote (wild type)

+ / e: gray heterozygote (wild type)
 e / e: ebony homozygote (mutant allele)

Also for wrinkled, we have similar results as follows:

+/+
 +/Wr
 Wr/Wr

This system described above works well with alleles which are either dominant or recessive to one another. If there is no dominance, we may simply use the upper case letters and superscript to denote alleles. e.g.

R¹ and R² or L^M and L^N or I^A and I^B.

ALLELIC RELATIONSHIPS

Possible allelic relationships are:

1. Dominant and recessive alleles
2. Incomplete dominance
3. Co-dominant or intermediate alleles
4. Lethal alleles
5. Multiple alleles

DOMINANT AND RECESSIVE ALLELES

The allele which can phenotypically express itself in the heterozygote as well as in the homozygote is called a dominant factor, and whenever one of a pair of alleles can come to phenotypic expression only in a homozygous genotype we call that allele a recessive factor.

Upper case and lower case letters are commonly used to designate dominant and recessive alleles respectively.

Usually, the genetic symbol corresponds to the first letter in the name of the mutant (abnormal) trait is used. For example, lack of pigment deposition in the human body is an abnormal recessive trait called **albinism**. Using A to represent the dominant (normal) allele and "a" to represent recessive (albino), three possible genotypes and two phenotypes are possible, i.e.

Genotypes	Phenotypes
AA (homozygous dominant)	Normal pigment
Aa (heterozygous)	Normal pigment
aa (homozygous recessive)	Albino (no pigment)

If the mutant gene is recessive, the symbol would be a lower case letter(s) corresponding to the initial letter(s) in the name of the trait. Its normal wild-type dominant allele would have the same lower case letter but a + as superscript. For example, black body colour in fruit fly is governed by a recessive gene b, and the wild type (gray body) is dominant allele b⁺.

If the mutant trait is dominant the base symbol would be an upper case letter without a superscript. e.g. lobe shaped eyes in Drosophila (fruit fly) are gene L and wild type (oval eye) by its recessive allele L⁺.

Here, we need to remember that the case of the symbol indicates the dominance or recessive of the mutant allele to which the superscript + for wild type must be referred. After the allelic relationships have been defined, the symbol + by itself may be used for wild type and the letter alone may designate mutant type.

PARTIAL OR INCOMPLETE DOMINANCE

When two parents with contrasting traits are crossed or mated and in the offspring produced, neither of the parental traits masked the other, then we say that incomplete or partial dominance had occur. Incomplete or partial dominance in the offspring is based on the observation of intermediate phenotypes generated by a cross between parents with contrasting traits. For example, if plants with red flowers are crossed with another with white flowers, and the offspring produced have pink flowers. It appears that neither red nor white flower colour is dominant.

Since some red pigment is produced in the F_1 intermediate coloured pink flowers, dominance appears to be incomplete or partial.

If the resulting F_1 of the above cross are further crossed *inter se* (i.e. selfing) i.e. $F_1 \times F_1$, the resulting F_2 generation will give a genotypic ratio of (1:2:1) showing that only one pair of allele determines these phenotypes. The genotypic ratio (1:2:1) of the F_2 generation is identical to that of Mendel's monohybrid cross.

The crossing describe above can be represented as follows:

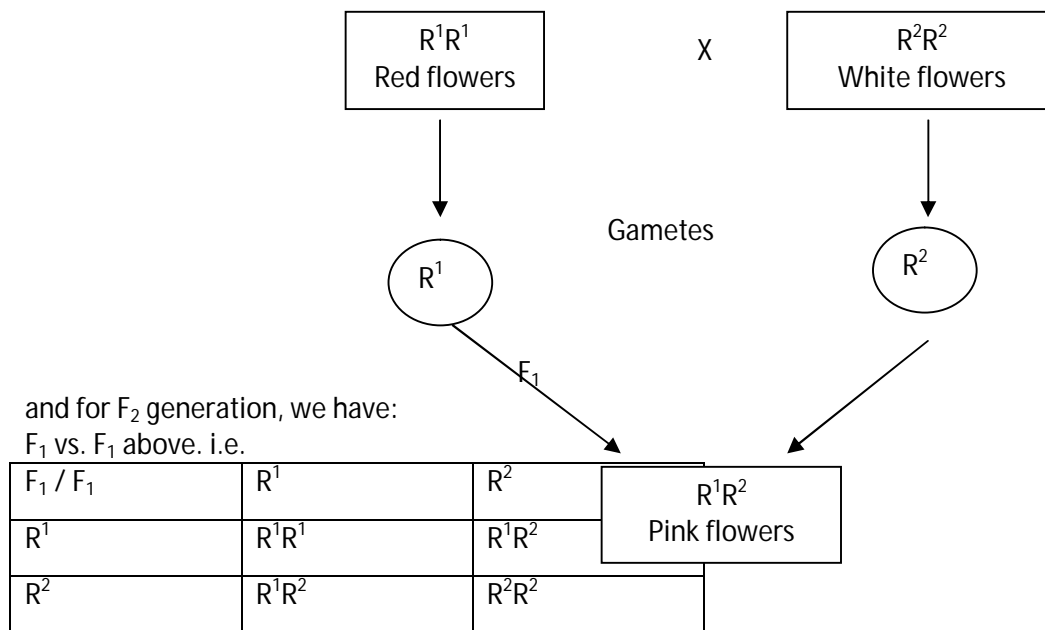

Therefore, proportion of red flower in the Punnett square above is

$$\frac{1}{4}R^1R^1 = 0.25 R^1R^1 \text{ red flower,}$$

and

$$\frac{2}{4}R^1R^2 = \frac{1}{2} R^1R^2 = 0.50R^1R^2 = \text{pink flower}$$

and

$$\frac{1}{4} R^2R^2 = 0.25R^2R^2 = \text{white flower}$$

Therefore, the genotypic ratios are: 0.25: 0.50: 0.25 \rightarrow 1:2:1

Because there is no dominance, however, the phenotypic ratio is identical to the genotypic ratio, and since neither of the alleles is recessive, it is not necessary to use upper or lower case letters and hence the reason for using R^1 and R^2 to represent red and white alleles. It is also possible to use other designations such as W^1 and W^2 or C^R and C^W where 'C' represents colour.

CODOMINANT OR INTERMEDIATE ALLELES

Alleles which lack dominant and recessive relationships may be called intermediate or co-dominant alleles. This means that each allele is capable of some degree of expression when in the heterozygous condition. The heterozygous genotype gives rise to a phenotype distinctly different from either of the homozygous genotypes. Usually, the heterozygous phenotype resulting from co-dominance is intermediate in character between those produced by the heterozygous genotypes.

SYMBOLISM FOR CO-DOMINANT ALLELES

For co-dominance or intermediate alleles, all upper case base symbols with different superscripts are used. The upper case letters shows that each allele can express itself to some degree even when in the presence of its alternative allele or heterozygous.

A good example of this is the MN-blood group in humans. The alleles governing the MN blood group system in humans are co-dominant and may be represented by the symbols L^M and L^N . The base letter (L) being assigned in honour of its discoverers (**Karl Landsteiner and Philip Levine**). An individual may exhibit either one or both of them. The MN system is under the control of an autosomal locus found on chromosome 4 and two alleles designated L^M and L^N . Because humans are diploid, three combinations are possible, and each resulting in distinct blood type.

Genotype	Phenotype/Blood group
$L^M L^M$	M
$L^M L^N$	MN
$L^N L^N$	N

A mating between two MN parents may produce children of all three blood types i.e.

$$L^M L^N \times L^M L^N$$

Female/Male	L^M	L^N
L^M	$L^M L^M$	$L^M L^N$
L^N	$L^M L^N$	$L^N L^N$

From the table above, proportion of $L^M L^M = \frac{1}{4} = 0.25$, and

$$L^M L^N = \frac{2}{4} = \frac{1}{2} = 0.50, \text{ and}$$

$$L^N L^N = \frac{1}{4} = 0.25$$

From the Punnett square above, we have $\frac{1}{4} L^M L^M$ or $0.25 L^M L^M$

$$\frac{1}{2} L^M L^N \text{ or } 0.50 L^M L^N$$

And $\frac{1}{4} L^N L^N$ or $0.25 L^N L^N$

Co-dominance results in distinct evidence of the gene products of both alleles. Individual expression of each allele is apparent.

Example I:

Coat colour of the Shorthorn breed of cattle represents a classical example of co-dominance allele. Red is governed by the genotype $C^R C^R$, roan (mixture of red and white) by $C^R C^W$, and white by $C^W C^W$.

- When roan Shorthorns are crossed among themselves, which genotypic and phenotypic ratios are expected among their progeny?
- If red shorthorns are crossed with roans and the F1 progeny are crossed among themselves to produce the F2, what percentage of the F2 will probably be roan?

Solution

Given genotypes are

Red = $C^R C^R$

Roan = $C^R C^W$

White = $C^W C^W$

- Roan x Roan = $C^R C^W \times C^R C^W$, using Punnett square:

Female/Male	C^R	C^W
C^R	$C^R C^R$	$C^R C^W$
C^W	$C^R C^W$	$C^W C^W$

The F_1 produced from the table when roans are crossed themselves gives $\frac{1}{4}C^R C^R$, $\frac{1}{2}C^R C^W$ and $\frac{1}{4}C^W C^W$ or $0.25C^R C^R$, $0.50C^R C^W$ and $0.25C^W C^W$.

The phenotypic ratio will be $0.25C^R C^R$, $0.50C^R C^W$ and $0.25C^W C^W = 1:2:1$

Therefore, the phenotypic ratio 1:2:1, corresponds to the same genotype ratio.

- Red x roan = $C^R C^R \times C^R C^W$. Then using Punnett square for the crossing:

	C^R	C^R
C^R	$C^R C^R$	$C^R C^R$
C^W	$C^R C^W$	$C^R C^W$

From the table above, we have

$$\frac{2}{4} C^R C^R = \frac{1}{2} C^R C^R$$

and

$$\frac{2}{4} C^R C^W = \frac{1}{2} C^R C^W$$

∴ The F_1 from the table above is $\frac{1}{2} C^R C^R$: $\frac{1}{2} C^R C^W$

To produce F_2 , the F_1 can be mated *inter se* or when there is selfing we have:

$F_1 \times F_1$

i.e. male

	(1) $\frac{1}{2} C^R C^R$ (M)	$\frac{1}{2} C^R C^W$ (M)
$\frac{1}{2} C^R C^R$ (F)	(1) $\frac{1}{4} C^R C^R$ (F) x $C^R C^R$ (M)	(2) $\frac{1}{4} C^R C^R$ (F) x $C^R C^W$ (M)
$\frac{1}{2} C^R C^W$ (F)	(2) $\frac{1}{4} C^R C^W$ (F) x $C^R C^R$ (M)	(3) $\frac{1}{4} C^R C^W$ (F) x $C^R C^W$ (M)

Note:

The m and f are only used to indicate male and female involved in the crossing.

From the table above, three types of matings are possible for the production of F_2 . Their relative frequencies of occurrence may be calculated using the mating table. The 1, 2, and 3 in the table shows the type of matings possible.

- Is the mating of $C^R C^R_F \times C^R C^R_{(m)}$ (i.e. red x red) produces only red $C^R C^R$ progeny, but only one-quarters of all matings are of this type. Therefore, only $\frac{1}{4}$ of all the F_2 should be red from this source.
- The matings $C^R C^W \times C^R C^R$ i.e. roan female x red male are expected to produce $\frac{1}{2} C^R C^R$ (red) and $\frac{1}{2} C^R C^W$ (roan) progeny. Half of all matings are of this kind. Therefore $\frac{1}{2} \times \frac{1}{2} = \frac{1}{4}$ of all the F_2 progeny should be red and $\frac{1}{4}$ should be roan from this source.

3. The mating $C^R C^W$ (female) x $C^R C^W$ (male) i.e. roan x roan is expected to produce $\frac{1}{4} C^R C^R$ (Red), $\frac{1}{2} C^R C^W$ (Roan), and $\frac{1}{4} C^W C^W$ (white) progeny. This mating type constitutes $\frac{1}{4}$ of all crosses. Therefore, the fraction of all F₂ progeny contributed from this source is $\frac{1}{4} \times \frac{1}{4} = \frac{1}{16} C^R C^R$, $\frac{1}{4} \times \frac{1}{2} = \frac{1}{8} C^R C^W$ and $\frac{1}{4} \times \frac{1}{4} = \frac{1}{16} C^W C^W$.

LETHAL ALLELES

The phenotypic manifestation of some genes causes the death of individual either in the pre-natal or post-natal period prior to maturity. Such factors are called **lethal genes**.

A fully dominant lethal allele is one which kills in both the homozygous and heterozygous conditions and occasionally arises by mutation from normal allele. Individuals with a dominant lethal die before they can leave progeny.

Recessive lethal kill only when homozygous and may be of two kinds viz:

- One which has no obvious phenotypic effect in heterozygotes and
- One which exhibits a distinctive phenotype when heterozygous

Example:

A completely recessive lethal (l) can sometimes be identified in certain families

Genotype	Phenotype
LL, Ll	Normal
ll	Lethal

Or

The amount of chlorophyll in some plants is controlled by an incompletely recessive gene which exhibits a lethal effect when homozygous and a distinctive phenotypic effect when heterozygous.

Genotype	Phenotype
CC	Green (normal)
Cc	Pale green
cc	White (lethal)

Example II:

The absence of legs in cattle (amputated) has been attributed to a completely recessive lethal gene. A normal bull is mated with a normal cow and they produce an amputated calf usually dead at birth. The same parents are mated again.

- What is the chance of the next calf being amputated?
- What is the chance of these parents having two calves, both of which are amputated?

Solution

If phenotypically normal parents produce an amputated calf, they must both be genetically heterozygous i.e.

Aa x Aa

Normal Normal

Therefore this crossing will produce

	A	a
A	AA (normal)	Aa (normal)
a	Aa (normal)	aa (amputated)

Therefore, from the table above, we would have

$\frac{1}{4}$ AA, $\frac{2}{4}$ or $\frac{1}{2}$ Aa and $\frac{1}{4}$ aa

Total normal = $\frac{1}{4}$ AA + $\frac{1}{2}$ Aa = $\frac{3}{4}$ normal and $\frac{1}{4}$ amputated (dies). This means that there is a 25% chance of the next offspring being amputated.

b. The chance of the first calf being amputated and the second calf also being amputated is the product of the separate probabilities i.e.

$$\frac{1}{4} \times \frac{1}{4} = 1/16$$

In some case, the allele responsible for a lethal effect when homozygous may result in distinctive mutant respect to the phenotype. An example of this can be seen clearly when agouti mice are crossed. Crosses between the various combinations of the two strains yielded unusual results.

For example

Cross A = Agouti x agouti

$$(AA) \times (AA) \rightarrow \text{All agouti}$$

$$A \times A = AA = F_1$$

Result of cross A is that all F1 are agouti (AA) and they will survive.

Cross B, yellow mice x yellow mice = 2/3 yellow and 1/3 agouti.

i.e

$$AA^Y \times AA^Y$$

	A	A ^Y
A	AA (agouti)	AA ^Y (yellow)
A ^Y	AA ^Y (yellow)	A ^Y A ^Y lethal

From cross B, result of F1 are 2/3 yellow (i.e. AA^Y) and 1/3 agouti (AA) but A^YA^Y is lethal and die before birth.

For cross C

Agouti X yellow i.e.

$$AA \times AA^Y$$

	A	A
A	AA	AA
A ^Y	AA ^Y	AA ^Y

From this table, we have 2/4 AA = 1/2 AA = 1/2 agouti and 2/4 AA^Y = 1/2 yellow.

For cross C, the result is 1/2 agouti AA and 1/2 AA^Y yellow all survived.

MULTIPLE ALLELES

Information stored in any gene is extensive and mutations may modify this information in many ways. Each change has the potential of producing a different allele. Therefore, at any given locus (i.e. the position or place on a chromosome occupied by a particular gene or one of its alleles) on the chromosome, the number of alleles within a population of individuals need not be restricted to only two. When three or more alleles are found for any particular gene, the mode of inheritance is called **Multiple allelism**.

The concept of multiple allele refers to a definite group of animals or population not to a single individual which always has only two genotypes of a given series in its genotype.

Common examples of concept of multiple alleles are

- i. Coat colour in rabbits
- ii. The ABO blood types in humans

COAT COLOUR IN RABBIT

The coat colour of the ordinary or wild type rabbit is referred to as agouti or individual have banded hairs, the portion nearest the skin being gray, succeeded by a yellow band and finally a black or brown tip.

Apart from agouti, the albino rabbit has also been identified. These rabbits are totally lacking in pigmentation. Crosses of homozygous agouti and albino individual produce uniform agouti F1, inter breeding of the F1 produces and F2 ratio of 3 agouti: 1 albino. Other individuals, lacking yellow pigment in the coat, have a silvery – gray appearance because of the optical effect of black and gray hairs. This phenotype or type of rabbit is called the Chinchilla. Crosses between chinchilla and agouti produce all agouti individuals in the F1 and a 3 agouti: 1 chinchilla ratio in the F2. Therefore, genes determining Chinchilla and agouti appear to be alleles, with agouti being dominant.

If however, the cross chinchilla x albino is made, the F1 are all chinchilla, and the F2 shows 3 chinchilla: 1 albino. Here again genes for chinchilla and albino are also allele and agouti, chinchilla and albino are said to form a multiple allele series. Apart from agouti, chinchilla and albino, another type of rabbit phenotypes common is the Himalayan rabbit. The coat is white except for black extremities on nose, ears, feet and tail. Eyes are pigmented, unlike albino. These four rabbit phenotypes have been identified and the gene symbols often assigned are

- agouti C^+
- Chinchilla C^{ch}
- Himalayan c^h
- Albino c

From several crosses of rabbit types, the following dominance interrelationships or hierarchy has been established:

$$C^+ > C^{ch} > c^h > c$$

Based on this it is possible to predict F1 and F2 progeny for two crosses and deduce their genotypes.

Phenotypes and their associated genotypes for this series in rabbit are as follows:

Phenotype	Genotype
Agouti	$C^+C^+, C^+C^{ch}, C^+c^h, C^+c$
Chinchilla	$C^{ch}C^{ch}, C^{ch}c^h, C^{ch}c$
Himalayan	c^hc^h, c^hc
Albino	cc

In the table above, ten different genotypes were derived.

THE ABO BLOOD TYPE

The simplest example of multiple alleles is that in which there are three alleles of one gene. This situation exists in the inheritance of the ABO blood types in humans.

Just like the MN blood system, one combination of alleles in the ABO system exhibits a co-dominance mode of inheritance. However, the ABO antigens are distinct from the MN antigens and are under the gene, located on chromosome a. the various blood types different antigens. Antigens molecules upon exposure to antibodies evoke an immune reaction.

Note:

An antigen is any substance usually a protein that causes antibody production when introduced into a living organism while antibody or antibodies is/are Y-shaped protein molecules that acts to neutralize a specific antigen in a living organism.

When a specific antigen meets a proper antibody the two forms a complex and initiate a reaction that tends to destroy the antigen and their carrier. The member of the multiple allelic series of genes can specify whether or not an immune reaction takes place between two systems. The most common blood group difference in humans involves the ABO system.

When the blood of individuals of certain genotypic constitution is mixed, the red blood cells may form clumps or agglutination.

Mixing the blood of two individuals of identical or proper genotypes does not lead to clumping. Agglutination prevents the free flow of blood in the veins and oxygen transfer, therefore, it can cause death.

For example, there will be clumping when individual with blood group A is mixed with B and AB. Similarly blood group B mixed with A and AB will cause clumping.

When O type individual is mixed with A, B and AB there will be clumping

Blood types acceptable for transfusion are

Blood group	Type acceptable for transfusion
A	A, O
B	B, O
AB	A, B, O
O	O

At the ABO gene locus three major alleles are known. The O blood type is determined by the homozygosity of the recessive i^o alleles. Alleles I^A and I^B are co-dominant. Different designations may be used and for convenience, we can use the symbols I^A , I^B and I^O for the three alleles. The 'I' designation stands for **ISOAGGLUTINOGEN** which is another term for **antigen**.

If we assume that I^A and I^B alleles are responsible for production of A and B antigens and that I^O do not produce any detectable A or B antigens, the various genotypic possibilities and appropriate phenotype for each on the general characteristics can be written as:

Genotype	Phenotype or blood group	Antigens	Antibodies	Clumping with	Blood type acceptable for transfusion
$I^A I^A$ or $I^A I^O$	A	A	Anti – B	B, AB	A, O
$I^B I^B$ or $I^B I^O$	B	B	Anti – A	A, AB	B, O
$I^A I^B$	AB	A, B	Neither	Neither	A, B, O
$I^O I^O$	O	Neither A nor B antigen	Anti – A and Anti B	A, B, and AB	O

In the table above, it must be noted that alleles I^A and I^B both behaves dominantly to allele I^O , but co-dominantly to each other.

It is possible to test easily that three alleles control ABO blood types by examining potential offspring from many combinations of matings as shown in the table. If we assume heterozygosity, we can predict which phenotypes can occur. The hypothesis that three alleles control ABO blood types in human population is now universally accepted.

MEDICOLEGAL ASPECTS OF THE ABO SERIES

Compatible blood transfusion can be achieved and decisions about disputed percentage more accurately made. The latter cases can occur when newborns are inadvertently mixed up in the hospitals or when it is uncertain whether a specific male is the specific male is the father of a child. In both cases, an examination of the ABO phenotypes as well as other inherited antigens of the possible parents and the child may help to resolve the situation. The table below also demonstrates numeracy cases where it is impossible for a parent of a particular ABO phenotype to produce a child of certain phenotype. The only mating that can result in offspring of all four phenotypes is between two heterozygous individuals, one having the A phenotype and the other having the B phenotype. e.g. crossing $I^A I^O \times I^B I^O$, will produce children having all the blood group A, B, AB and O i.e.

	I^A	I^O
I^B	$I^A I^B$	$I^B I^O$
I^O	$I^A I^O$	$I^O I^O$

Genotype and phenotypes blood group in this table will be

Genotype	Phenotype / blood group
$I^A I^B$	AB
$I^B I^O$	B
$I^A I^O$	A
$I^O I^O$	O

On a genetic ground alone, a male or female may be unequivocally ruled out as the parent of a certain child. On the other hand, this type of genetic evidence never proves parenthood.

Potential phenotypes in the offspring of parents with ABO blood type combinations assuming heterozygosity whenever possible

Genotypes	Phenotypes	F ₁ phenotypes OR Potential Offspring			
		A	B	AB	O
$I^A I^O \times I^A I^O$	A x A	3/4	-	-	1/4
$I^B I^O \times I^B I^O$	B x B	-	3/4	-	1/4
$I^O I^O \times I^O I^O$	O x O	-	-	-	All
$I^A I^O \times I^B I^O$	A X B	1/4	1/4	1/4	1/4
$I^A I^O \times I^A I^B$	A x AB	1/2	1/4	1/4	-
$I^A I^O \times I^O I^O$	A x O	1/2	-	-	1/2
$I^B I^O \times I^A I^B$	B x AB	1/4	1/2	1/4	-
$I^B I^O \times I^O I^O$	B x O	-	1/2	-	1/2
$I^A I^B \times I^O I^O$	AB x O	1/2	1/2	-	-
$I^A I^B \times I^A I^B$	AB x AB	1/4	1/4	1/2	-

How to calculate number of genotypes when numbers of alleles are known

The number of genotypes within alleles present in the series can be expressed at anytime by using the following formula:

$$N = \frac{n^2 + n}{2}$$

where, N = Number of genotypes from a given number of alleles (n)

A single pair of alleles at a given locus produces three genotypes. By the same token, a series of multiple alleles produce six genotypes. It must therefore be noted that as the number of genes in a series of multiple alleles increase, the variety of genotype rise still more rapidly

Example

Number of alleles in series (n)	Number of genotypes (N)
n = 2	$\frac{2^2 + 2}{2} = 3 = N$
n = 3	$\frac{3^2 + 3}{2} = 6 = N$
n = 4	$\frac{4^2 + 4}{2} = 10 = N$
n = 5	$\frac{5^2 + 5}{2} = 15$
n = 6	$\frac{6^2 + 6}{2} = 21, \text{ etc}$

Study questions and answers on blood type

Example 1: A woman accused of abandoning a baby claims that she never gave birth to any baby. The blood types of the woman and the baby are as follows

Woman	AB	cc	dd	Ee	M
Baby	O	Cc	D	ee	N

Could the woman have born the baby?

Solution

Let us start with the ABO group and see if she could have born a type O baby. The thing to check is whether she could contribute any of genes to the child.

She does not have to contribute all of them, because the father will of course supply gene also. The ABO data show that she is telling the actual truth because an AB woman produces only AI and IB gametes and hence cannot have a type O i.e. I⁰I⁰ child.

The MN data are also supportive because an M woman cannot have N child, she could only have an M or an MN depending on the genotype of the father.

Example II: After delivery in the hospital, there was a mix u of two babies in a maternity ward, both babies and their parents are blood typed. Match each child with its proper parents.

Mother 1	O	Cc	D	Ee	M
Father 1	AB	cc	D	ee	MN
Mother 2	A	cc	dd	ee	N
Father 2	O	CC	D	ee	N
Baby 1	A	Cc	dd	Ee	M
Baby 2	A	Cc	dd	ee	N

Answer:

Couple 1 can have an M or MN baby, but not AB N. Couple 2 has no E value and hence cannot have Ee baby. Thus, baby 1 belongs to couple 1, and baby 2 belongs to couple 2.

Example III:

What blood type could a child born of a type O mother and a type B father?

Solution

Since the mother is type O, the genotype of the mother is then $I^O I^O$ and the gamete she could produce is I^O and father is type B blood, the genotype of the father is then $I^B I^B$ or $I^B I^O$ and gamete the father can give is I^B .

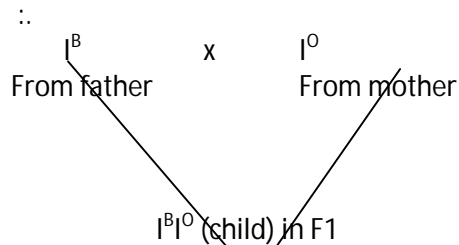

Therefore the genotype of the child produced is $I^B I^O$, meaning that the blood type of the child is B, because B is behaving dominantly in $I^B I^O$.

Example IV: A woman has a baby and that either of the two men could be its father. The blood group phenotypes of the individuals are

Mother	O	Cc	D	Ee	M
Child	O	CC	D	ee	M
Male 1	A	Cc	dd	EE	MN
Male 2	B	Cc	dd	Ee	N

Based on these phenotypes, can either male be excluded from paternity? Explain your reasoning.

Solution

Male 1 is excluded because the baby must have received a C allele from its father. Male 2 is equally excluded because the baby must have received an M allele from its father.

In majority of animals as well as dioecious plants (i.e. plants in which a given individual produces only sperm or egg) one pair of chromosomes can be distinguished morphologically from the rest. This pair of chromosomes has a role in sex determination. The chromosomes are called **sex chromosome**. All other chromosomes which are the same in both sexes are called the **autosomes**.

The number of sex chromosome may vary in certain species. Up to 8 – 12 sex chromosomes may occur in some lower animals, multiple sex chromosomes can also be found in some dioecious species of plants. Unlike the other chromosome pairs of a species (i.e. the autosome), the sex chromosome i.e. the X and Y chromosome differ from another in size i.e. they are of unequal size, shape and or straining qualities. Though, during meiosis they pair and act as a homologous segment.

In most animals and dioecious plants, the males contain one X and one Y chromosome (i.e. XY) and females have XX.

Birds, butterflies, some fishes and some species of strawberry plants have the reverse type of chromosomal sex determinations i.e. the females are equipped with an X and Y chromosome. In birds and butterflies, the sex chromosomal constitution is frequently denoted as ZW for female and ZZ for male.

The sex that can produce either X or Y chromosome containing gametes is called **heterogametic**. In the majority of species, with the exception of butterflies, some fishes, most silkworms, the females have two X chromosomes and are therefore called **homogametic**.

CLASSIFICATION OF SEX CHROMOSOMES IN DIPLOID ORGANISMS

Sex chromosomes in diploid organisms can be classified into four different methods:

- i. XX – XY method or **Lygaeus mode of sex determination**
- ii. XX – XO method or **Protenor mode of sex determination**
- iii. ZZ – ZW method
- iv. ZZ – ZO method

In the first two methods, the males are **heterogametic** i.e. produces two kinds of gametes as far as sex chromosomes are concerned, but the female produced only one kind of gamete and is called **homogametic sex**.

In methods (iii) and (iv) above, the male is homogametic sex and produces only one gamete whereas the female is the heterogametic sex as it produces two types of gametes.

XX – XY METHOD

In this case, the females were XX, but males were XY. Half the sperm carry an X and half a Y. The so-called XY type occurs in a wide variety of animals including *Drosophila melanogaster* (Fruit flies) and mammals and as well as in at least some plants e.g. angiosperm genus *Lychnis*.

XX-XO METHOD

In many insects e.g. bugs, grasshoppers and cockroaches there is a chromosomal difference between the sexes i.e. females are referred to as XX (i.e. having two X chromosome and male as XO) i.e. (having one X chromosome). In this case, all the eggs of such species carry an X chromosome. Only half the sperms have one X and the other half has none.

In both XX-XY and XX-XO methods described above, all the eggs have one X chromosome, whereas two kinds X and Y or X and O in the male and in each case the male is **heterogametic** (producing two kinds of gametes) whereas the female is **homogametic** sex (producing but one kind of gamete).

ZZ – ZW METHOD

In this case the male is **homogametic** while the female is **heterogametic**. Therefore, the females are thus ZW and males are ZZ. Birds, including the domestic fowl/chicken, butterflies and some fish,

reptiles, amphibians belong to this group. In fowl for example, the female is indeed heterogametic and is therefore characterized by the *Lygaeus* type of sex determination.

ZZ-ZO METHOD

In this case, the males (ZZ) are homogametic which the females (ZO) are heterogametic, but female only have one Z chromosome. Therefore, in both ZZ – ZW and ZZ – ZO, the females are heterogametic whereas the males are homogametic.

SUMMARY OF SEX CHROMOSOME TYPES

The various types of chromosomal differences between the sexes may be summarized as follow:

Females	Males	Examples
XX	XY	Drosophila, humans and other mammals
XX	XO	Bugs, grasshopper and cockroaches
ZW, ZO	ZZ, ZZ	Birds, butterflies, moths, some fish, amphibians, reptiles, etc.

N.B: Note that the W chromosome of the chicken is not a *strong female determining element*. Recent investigations shows that sex determination in chickens and other birds is dependent upon the ratio between the Z chromosomes and the number of autosomal sets of chromosomes

The four sex chromosome methods of sex determination

XY method of sex determination

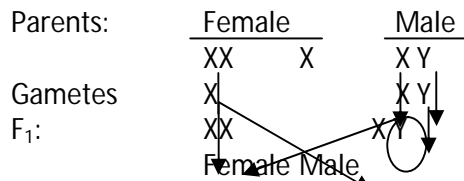

This crossing will produce a 1: 1 sex ratio in each generation.

XO method of sex determination

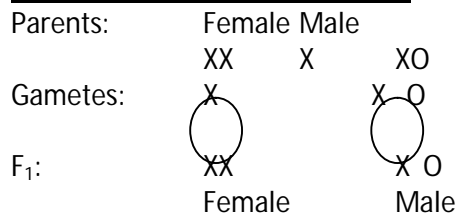

In this case too, a 1:1 sex ratio is produced in the progeny.

In both examples above, the male XY or XO are the **heterogametic sexes** while the XX female is homogametic.

ZW method of sex determination

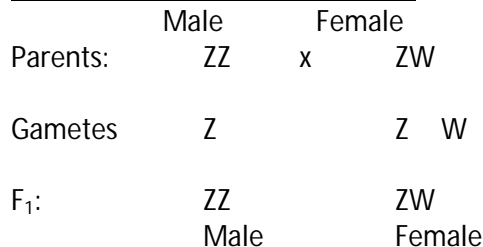

Note: also that 1:1 sex ratio also occur here.

ZO method of sex determination

	Male	female
Parents:	ZZ	X ZO
Gametes	Z	Z O
F ₁ :	ZZ	ZO
	Male	Female

In both ZZ – ZW and ZZ – ZO, the heterogametic females are ZW and ZO, but ZZ is the homogametic males.

INTERSEXES

In some organisms e.g. *Drosophila melanogaster* (Fruit fly), some individuals are very large, exhibited a variety of morphological abnormalities, usually very sterile and expressed both male and female morphology. Individuals exhibiting these are called **intersexes**. **Intersexes** are sterile individuals that display secondary sex characters between those of male and female. In such individuals, the ratio of number of X chromosomes to the number of sets of autosomes (A) when calculated is greater than 0.5 but less than 1.0 (i.e X/A is > 0.5 but < 1.0). This method was developed by Calvin Bridges in 1916 and is still been used till date.

Bridges realized that the critical factor determining sex is the ratio of X chromosomes to the number of sets of autosomes (A) that is present. Normal (2X:2A) and triploid (3X:3A) females each have a ratio equal to 1.0, and both are fertile. As the ratio exceeds unity (3A:2A or 1.5, for example), we have what is called **superfemale** or what is now called **metafemales**. Normal (XY:2A) and sterile (XO:2A) males each have a ratio of 1:2, or 0.5. When the ratio decreases to 1:3, or .33, as in the case of an XY:3A male, infertile metamales result. Other flies recovered by Bridges had X:A intermediate between 0.5 and 1.0. These flies are generally larger, sterile and display secondary sex characters between males and females and are appropriately called intersexes.

The mechanism of sex differentiation in *Drosophila* may be summarized as follows:

- Sex is governed by the ratio of number of X chromosomes to the sets of autosomes. Thus, females have X/A ratio =1.0; males = 0.5
- Gene for maleness per se are apparently carried on the autosome, those for femaleness on the X chromosome.
- The Y chromosome governs male fertility rather the sex itself.
- An X/A ratio greater than 1.0 or less than 0.5 (> 1.0 or < 0.5) results in certain characteristic malformations (i.e. **metafemales and metamales**).
- An X/A ratio (< 1.0 but > 0.5) produces individuals intermediate between males and females (intersexes). The degree of femaleness is greater where X/A ratio is closer to 1.0, and the degree of maleness is greater where that ratio is closer to 0.5.

The table below explains the formation of intersexes and other sexual morphology seen in *Drosophila melanogaster*.

Chromossome formulation (Note: The numerators are the assumed X chromosome numbers and the denominators are the number of sets of autosomes)	Ratio of X chromosomes to autosome sets	Resultant sexual morphology or sex designation
3X/2A	1.5	Metafemale
3X/3X	1.0	Female
2X/2A	1.0	Female
3X/4A	0.75	Intersex
2X/3X	0.67	Intersex

X/2A	0.50	Male
XY/2A	0.50	Male
XY/3A	0.33	Metamale

SEX DIFFERENTIATION

1. **Genetic Sex:** Normal females have two X chromosomes, normal male have one X and one Y. Genes on these chromosomes determines femaleness or maleness. Therefore, one can say that females have genetic sex designation XX and males having the XY although exceptional cases do occur.
2. **Gonadal sex:** Chemical substances called **inductors** produced by embryonic XX cells act on the cortical region of undifferentiated gonads to bring about development of ovarian tissue. In XY embryos, however, inductor stimulates production of testes from medulla of the undifferentiated gonads. Hence, the XX genetic sex is associated with ovarian gonadal sex and XY with testicular gonadal sex.
3. **Genital sex:** XX embryos normally developed ovaries, female external genitalia and Mullerian ducts. XY embryos develop testes, male external genitalia and Mullerian ducts. XY embryos develop testes, male external genitalia and Wolffian ducts. In XX embryos, Wolffian ducts are suppressed, in XY embryos, the Mullerian ducts remain undeveloped. Thus, there is a distinction between male and female genital sex.
4. **Somatic sex:** production of gonadal hormones continues to increase until at puberty when secondary sex characteristics appear. These include amount and distribution of hair (e.g. facial, body, pubic etc), general body proportions, fats over hips and thighs and breast development in the females as well as increased larynx size and deepening of the voice in the male.
5. **Sociopsychological sex:** In most individuals, genetic, gonadal, genital and somatic sexes are consistent. XX persons for example develop ovaries, female genitalia, female secondary sex characters. These persons are raised as females and adopt the feminine gender role under whatever cultural pattern has been established in the society of which they are members. A similar consistency from genetic sex to sociopsychological sex is seen for XY individuals. On the other hand, some individuals display an inconsistency of some kind or degree among these levels of sexuality. Discordance involving the genetic and anatomical result in inter-sexuality

TWO COMMON SEX CHROMOSOME ANOMALIES IN HUMANS

These are the **Klinefelter syndrome** (47,XXY) and the **Turner syndrome** (45,X).

CHARACTERISTICS OF INDIVIDUALS WITH KLINEFELTER SYNDROME

- (i) This syndrome is commonly seen in males and affected individuals are tall, having long arms and legs and large hands and feet
- (ii) They usually have genitalia and internal ducts that are male, testes are rudimentary and fail to produce sperm.

- (iii) There is slight enlargement of the breast, a condition known as **gynecomastia**. This ambiguous sexual development is often referred to as **intersexuality** and can lead to abnormal social development.
- (iv) Hips are often rounded
- (v) Intelligence of affected individual is often below normal

CHARACTERISTICS OF INDIVIDUALS WITH TURNER SYNDROME

- i. In turner syndrome, affected individual has female external genitalia and internal ducts, but the ovaries are rudimentary
- ii. Affected individuals always have short stature (usually below 5 ft)
- iii. There is underdeveloped breasts and at times, a broad chest may be noted.
- iv. Intelligence of individuals with Turner syndrome is usually normal.

General forms/designations of these two syndromes in humans are shown in the table below.

However, a **47,XYY or for short XYY condition** is a form of Klinefelter syndrome that need special consideration (*See table below*).

Sex chromosome anomalies in human and their frequencies

Designation	Chromosome constitution	Karyotype designation	Somatic chromosome number	General sex phenotype or seen in	Signs / characteristic	Usual fertility	Estimated frequency per 1000 births	Estimated number
Klinefelter syndrome	AAXXY	47XXY	47	Males	Affected males have undeveloped testis that cannot produce sperm. Testes are very small. Affected men are mentally retarded, arms are longer, unusual breast development	sterile	2.0	Very high
Klinefelter syndrome XXYY	AAXXYY	48XXYY	48	Males	Manifestations are more severe than 47 XXY type	Not reported	Very low	Very low
Klinefelter XXXYY	AAXXXY	49XXXYY	49	Males	Manifestations are severe than 47XXY type	Not yet report	Very low	Very low
XYY	AAXYY	47XYY	47	Males	Affected individuals have low or subnormal intelligence, there is low sperm count, Affected males with XYY are more aggressive and commit crimes of violence than normal males. However, in some countries individuals with this karyotype are critically been examined before judgement is passed and at times, judges are been lenient in their judgement for individual with XYY karyotype. <i>It must be noted that the general sex phenotype of individual with XYY is male.</i>	Generally highly infertile	0.7 – 2.0	Very high
Triplo, X, Y	AAXXXY	48XXXYY	48	Males	Manifestations are severe than 47XXY type Very severe manifestations and sperm count is also very low.	Cannot produce	Very low	Very low
Tetra-X, Y	AAXXXXY	49XXXYY	49	Males		Cannot produce at all		
Turner syndrome	AAXO	45, X	45	Females	Affected individuals has female external genitalia and internal ducts, but ovaries are rudimentary, individual appear very short in stature, broad chest and webbed neck	Cannot produce, but if not severe, very few cases of motherhood have	1 in 3000 births of females, a frequency lower than Klinefelter syndrome	Very high

						been reported		
Triplo – X	AAXXX	47XXX	47	Female	Results in female differentiation, sterility or mental retardation, undeveloped secondary sexual characteristics.	Affected women in this case are perfectly normal	1 in 1200 female birth	Very high
Tetra – X	AAXXXX	48XXXX	48	Females	Syndromes associated with this karyotype are similar, but more pronounced than 47XXX. Disruption of delicate balance of genetic information for female development. Affected females have low intelligence	Unknown	Very low	Very low
Penta – X	AAXXXXX	49XXXXX	49	Female	Syndrome more severe than 47 XXX and the extra X chromosome disrupt the delicate balance of genetic information necessary for normal female development. Affected female have progressively reduced intelligence.	Affected women cannot produce	Very low	Very low

Karyotypes, other than 45, X also lead to Turner syndrome. These include individuals called **mosaics** with two apparent cell lines, each exhibiting a different karyotype. Such cell lines result from a mitotic error during early development. The most common chromosome combinations being **45, X/46, XY and 45, X/46, XX**.

The occurrence of the Turner syndrome is not as high as that of Klinefelter syndrome. One possible explanation for this is that most of the 45, X fetuses die in utero and are aborted spontaneously.

CAUSES OF KLINEFELTER AND TURNER SYNDROME

Both syndromes results from non-disjunction of the X chromosomes during meiosis. These karyotypes and their corresponding sexual phenotypes allow us to conclude that the Y – chromosome determines maleness in humans. In its absence, the sex of the individual is female, even if only a single X – chromosome is present.

Non-disjunction is the failure of paired chromosomes to segregate or separate during the anaphase stage of the first or second meiotic division. The result is the production of two abnormal gametes, one of which contains an extra chromosome ($n+1$) and the other lacks a chromosome ($n-1$). Fertilization of such gametes produces $2n+1$ or $2n - 1$ aneuploid zygote.

MECHANISM OF SEX DETERMINATION IN HUMAN BEINGS

Individuals that have at least one Y chromosome are, with exception of unusual cases are ordinarily male with regard to external genitalia and general phenotype, though they may be sterile. In contrast, persons with one or more X chromosomes are ordinarily phenotypically female as long as no Y is present, though again, infertility sometimes occurs.

The usual situation in human beings may be summarized as follows:

1. Autosomes do not play any part in determining sex.
2. Genes on the Y chromosome determine maleness (provided a controlling – X linked gene permits testicular differentiation).
3. Genes on the X chromosome determine femaleness in the absence of any Ys.

SEX RATIO

The actual proportion of male to female offspring is called sex ratio.

In humans, one of the sexes is heterogametic (i.e. XY) and the other is homogametic (i.e. XX), the ratio of males to female is expected to follow the rule of Mendelian test cross (1:1 ratio).

In humans, there is a slight deviation from the expected 1:1 sex ratio. In many countries including those that have census exercise, the ratio of males to females in humans is still not 1:1. In some countries, number of males outnumber that of the females and in some, it is vice versa.

This deviation from the expected 1:1 is believed to be caused by:

1. Selective fertilization of the X or Y – chromosome bearing gametes, or
2. By differential survival of the two sexes previous to birth.

Sex ratio can be assessed in two ways:

- a. Primary sex ratio which reflects the proportion of males to females conceived in a population.
- b. Secondary sex ratio reflects the proportion of each sex that is born. The secondary sex ratio is much easier to determine than the primary; but has the disadvantage of not accounting for disproportionate embryonic or fetal mortality should it occur. In most countries of the world, secondary sex ratio in human population that had been determined using census data, does not equal to 1.0

COMPOSITION OF X AND Y CHROMOSOME

The sex chromosomes are quite dissimilar in size (i.e the X and Y are of different size). The sex chromosomes (X and Y) often are of unequal size, shape and or staining qualities. The Y

chromosome in normal male is considerably smaller and lacks most of the gene sites contained on the X. However, during meiosis, they often pair which indicates that they contain at least some homologous segments or portions or regions of the X that is homologous with a similar small bit of the Y.

Note the following very well:

Genes on the homologous regions of X and Y chromosomes are said to be **incompletely sex-linked or partially sex-linked** and may recombine by crossing over in both sexes just as do the genes loci on homologous autosomes.

Genes on the non-homologous or differential region of the X chromosome are said to be **completely sex-linked**.

Few genes are also known to settle in the **non-homologous or differential portion of the Y chromosome**. Such genes are completely Y-linked genes and are called **holandric genes**.

The non-homologous portions of X and Y chromosomes are also known as the **differential regions of X and Y chromosomes**.

In X chromosome, the differential region or the non-homologous portions are completely sex-linked, whereas the differential region or the non-homologous portions of Y contain holandric genes. The differential region of Y chromosome is subdivided into three other regions called **suppressor, promoter and fertility regions**. These three sub-regions contains essentially holandric genes. These various sections in the X and Y chromosomes are shown in the diagram below.

Note

X = X chromosome

Y = Y chromosome

The parts labeled "a" on both the X and Y chromosomes are the homologous portions or segments of the X and Y chromosomes and contain incompletely sex-linked genes.

The part labeled "b" on the Y chromosome is the non-homologous or the differential region of the Y chromosome which contain mainly holandric genes, or the Y-linked genes. The upper part of this region is called **suppressor region, the middle is the promoter and this is followed by the fertility region**. In short, these three sub-regions are properly called differential or non-homologous region of Y chromosome.

The part labeled 'c' on the X chromosome is called non- homologous or differential region of X chromosome and this region **contains completely sex-linked genes**.

HOLANDRIC GENES

These are genes that occur normally on the Y chromosome only and therefore are not expressed in females. In human, these genes are found in the differential or non- homologous portion of Y chromosome. In such cases, the trait would be expressed only in males and would always be transmitted from father to son. These genes are completely Y-linked or properly called the holandric genes.

SEX-LINKED OR X-LINKED GENES

Genes located exclusively on the X chromosome are called sex-linked or X-linked genes. These are genes located only on the X chromosome in XY species or the Z chromosomes in ZW species. These genes control sex-linked traits. Examples of such sex-linked traits in humans include:

1. Colour blindness and there are two types

- a. *Deutan* colour blindness
- b. *Protan* colour blindness

In deutan, the green sensitive cones are defective and this is due to an X-linked recessive gene. It affects human males more than females. It affects about 8% males and 0.75 of females. Deutan colour blindness appears to be the most commonly encountered sex-linked trait in human beings. When there is defect on the red-sensitive cones, we have what is called protan. This is much less common than deutan type, occurring in only 2% of males and in 4 women out of about 10,000.

2. Other common human sex-linked trait is the Haemophilia: Haemophilia is a well known disorder in which blood clotting is deficient because of a lack of the necessary substrate thromboplastin. Haemophilia is a sex-linked recessive condition. There are two common types of haemophilia and these are

- Haemophilia A
- Haemophilia B

Haemophilia A is characterized by lack of antihemophilic globulin (or Factor VIII). This is the most common of the haemophilic conditions.

Haemophilia B is popularly known as the **Christmas disease** and this occur as a result of deficiency of clotting Factor IX or plasma thromboplastic component (PTC). This is a milder form of the condition.

SEX-LINKED LETHAL

These are genes whose effect causes death. The gene for haemophilia is a recessive sex-linked lethal for it often cause death. Sex-linked lethal by bring about death will alter the sex ratio in a progeny.

A good example is the **Duchene or muscular dystrophy**. This is a life shortening disorder in which the affected individual, though apparently normal in early childhood, exhibits progressive wasting away of the muscles, resulting in confinement to a wheelchair by about age 12 and death in the teen years. Both haemophilia and Duchene are due to recessive sex-linked genes. At present, there are no known means of arresting this condition. The gene responsible is a lethal and will certainly change the sex ratio in a given group of offspring over time.

SEX-LIMITED GENES

Are those whose phenotypic expression is determined by the presence or absence of one of the sex hormones. Their phenotypic effect is limited to one sex or the other.

Sex-limited inheritance patterns are quite different from those of sex-linked genes. The latter may be expressed in either sex, though with differential frequency. Sex-limited genes express their effects in only one sex or the other, and their action is related to sex hormones. They are principally responsible for secondary sex characters.

Familiar examples of sex-limited traits are:

1. **Hen-feathering and cock-feathering in the domestic fowl.** For example, in some species of fowl, males and female may exhibit pronounced differences in plumage. In some species, males have long pointed and curved feathers on tail and neck, but feathers of the female are shorter and less curved. Males are cock-feathered and the females are hen-feathered.

For example in breeds called Sebright, birds of both sexes are hen-feathered. In other breed such as Hamburgs and Wyandottes, both males and females are hen-feathered. In the case of Leghorns, all the females are hen-feathered and males are cock-feathered (i.e they have long, pointed, curving neck and tail feathers)

Breeds	Genotype	Female	Male
Sebright bantams	HH	Hen-feathered	Hen-feathered
Hamburg and Wyandotte	Hh	Hen-feathered	Hen-feathered
Leghorns	hh	Hen-feathered	Cock-feathered

In this case, Sebright bantams are all *HH*, Hamburg and Wyandotte may be *H-* or *hh*; but Leghorns are all *hh*. Cockfeathering, where it occurs is limited to the male sex.

2. **Beard development in human beings is a sex-limited character** as men normally have beards whereas women normally do not, however when the sex hormone production is high, changes may result in a genuine bearded lady.

SEX-INFLUENCED GENES

Sex influenced genes are those whose dominance is influenced by the sex of the bearer. In other words, if the expression of a phenotype is not limited to one sex. In sex-influenced inheritance, individual's sex influences the phenotype.

In contrast to X-linked inheritance, patterns of gene expression may be affected by the sex of an individual even when the genes are not on the X chromosome. In numerous examples in different organisms, the sex of the individual plays a determining role in the expression of a phenotype. In some cases, the expression of a specific phenotype is absolutely limited to one sex; in others, the sex of an individual influences the expression of a phenotype that is not limited to one sex or the other. This distinction differentiates **sex-limited inheritance** from **sex-influenced inheritance**. In both types of inheritance, autosomal genes are responsible for the existence of contrasting phenotypes, but the expression of these genes is dependent on the hormone constitution of the individual.

Common examples of sex-influenced inheritance/trait include:

- i. Pattern baldness in humans. This is more prevalent in males than in female, where it is rare and usually involves marked thinning rather than total loss of hair on the top of the head.
- ii. Horn formation in sheep which is dominant in males
- iii. Coat pattern or spotting in cattle (Mahogany and white, which are dominant in males, recessive in females; Red and white are dominant in females, but recessive in males.

LECTURE 9

POLYGENIC INHERITANCE

The term “polygenic inheritance” is used to refer to the inheritance of quantitative traits, traits which are influenced by multiple genes, not just one. In addition to involving multiple genes, polygenic inheritance also looks at the role of environment in someone's development.

Because many traits are spread out across a continuum, rather than being divided into black and white differences, polygenic inheritance helps to explain the way in which these traits are inherited and focused. A related concept is [pleiotropy](#), an instance where one gene influences multiple traits.

Early Mendelian [genetics](#) focused on very simple genetic traits which could be explained by a single gene. For example, a flower might appear in either orange or yellow form, with no gradation between the colors. By studying plants and the ways in which they mutated, early researchers were able to learn more about the gene which determined flower color. However, by the early twentieth century, people were well aware that most traits are far too complex to be determined by a single gene, and the idea of polygenic inheritance was born.

One easily understood example of polygenic inheritance is height. People are not just short or tall; they have a variety of heights which run along a spectrum. Furthermore, height is also influenced by environment; someone born with tall genes could become short due to [malnutrition](#) or illness, for example, while someone born with short genes could become tall through genetic therapy. Basic genetics obviously wouldn't be enough to explain the wide diversity of human heights, but polygenic inheritance shows how multiple genes in combination with a person's environment can influence someone's [phenotype](#), or physical appearance.

Skin color is another example of polygenic inheritance, as are many congenital diseases. Because polygenic inheritance is so complex, it can be a very absorbing and frustrating field of study. Researchers may struggle to identify all of the genes which play a role in a particular phenotype, and to identify places where such genes can go wrong. However, once researchers do learn more about the circumstances which lead to the expression of particular traits, it can be a very rewarding experience.

In pleiotropy, on the other hand, *one* gene is responsible for multiple things. Several congenital syndromes are examples of pleiotropy, in which a flaw in one gene causes widespread problems for a person. For example, sickle cell [anemia](#) is a form of pleiotropy, caused by a distinctive mutation in one gene which leads to a host of symptoms. In addition to causing mutations, pleiotropy also occurs in perfectly normal genes, although researchers tend to use it to track and understand mutations in particular.

INHERITANCE

The acquisition of traits, characteristics and disorders from parents to their children by transmission of genetic information. Genes come in pairs: one originating from the father, the other from the mother. If an individual presents only the hereditary characteristics determined by one gene of the pair on an autosomal chromosome, that gene is called **dominant**. Conditions caused by such genes are said to show **autosomal dominant inheritance**.

If the individual does not present the hereditary characteristics unless both genes in a pair are of the same type, then the gene is called **recessive**. Conditions caused by such genes are said to show **autosomal recessive inheritance**.

Mendel's Laws

Mendel discovered that when crossing white flower and purple flower plants, the result is not a blend. Rather than being a mix of the two, the offspring was purple flowered. He then conceived the idea of heredity units, which he called "factors", one of which is a recessive characteristic and the other dominant. Mendel said that factors, later called genes, normally occur in pairs in ordinary body cells, yet segregate during the formation of sex cells. Each member of the pair becomes part of the separate sex cell. The dominant gene, such as the purple flower in Mendel's plants, will hide the recessive gene, the white flower. After Mendel self-fertilized the F1 generation and obtained the 3:1 ratio, he correctly theorized that genes can be paired in three different ways for each trait: AA, aa, and Aa. The capital "A" represents the dominant factor and lowercase "a" represents the recessive. (The last combination listed above, Aa, will occur roughly twice as often as each of the other two, as it can be made in two different ways, Aa or aA.)

Mendel stated that each individual has two factors for each trait, one from each parent. The two factors may or may not contain the same information. If the two factors are

identical, the individual is called homozygous for the trait. If the two factors have different information, the individual is called heterozygous. The alternative forms of a factor are called alleles. The genotype of an individual is made up of the many alleles it possesses. An individual's physical appearance, or phenotype, is determined by its alleles as well as by its environment. An individual possesses two alleles for each trait; one allele is given by the female parent and the other by the male parent. They are passed on when an individual matures and produces gametes: egg and sperm. When gametes form, the paired alleles separate randomly so that each gamete receives a copy of one of the two alleles. The presence of an allele doesn't promise that the trait will be expressed in the individual that possesses it. In heterozygous individuals the only allele that is expressed is the dominant. The recessive allele is present but its expression is hidden.

Mendel summarized his findings in two laws; the **Law of Segregation** and the **Law of Independent Assortment**.

Law of Segregation (The "First Law")

The Law of Segregation states that when any individual produces gametes, the copies of a gene separate so that each gamete receives only one copy. A gamete will receive one allele or the other. The direct proof of this was later found following the observation of [meiosis](#) by two independent scientists, the German botanist, Oscar Hertwig in 1876, and the Belgian zoologist, Edouard Van Beneden in 1883. In meiosis, the paternal and maternal chromosomes get separated and the alleles with the traits of a character are segregated into two different gametes.

OR

The two coexisting alleles of an individual for each trait segregate (separate) during gamete formation so that each gamete gets only one of the two alleles. Alleles again unite at random fertilization of gametes.

Law of Independent Assortment (The "Second Law")

The Law of Independent Assortment, also known as "Inheritance Law" states that alleles of different genes assort independently of one another during gamete formation. While Mendel's experiments with mixing one trait always resulted in a 3:1 ratio (Fig. 1) between dominant and recessive phenotypes, his experiments with mixing two traits (dihybrid cross) showed 9:3:3:1 ratios

LECTURE 9

BREEDING

Plant breeding is the art and science of changing the genetics of [plants](#) for the benefit of mankind.^[1] Plant breeding can be accomplished through many different techniques ranging from simply selecting plants with desirable characteristics for propagation, to more complex molecular techniques.

Animal breeding is a branch of [animal science](#) that addresses the evaluation (using [best linear unbiased prediction](#) and other methods) of the genetic value (estimated breeding value, EBV) of domestic livestock. Selecting animals for breeding with superior EBV in growth rate, egg, meat, milk, or wool production, or have other desirable traits has revolutionized agricultural livestock production throughout the world.

The two methods of reproduction

Asexual reproduction means reproducing without the interaction of two sexes or genders, whereas **sexual reproduction** involves the fusion of two special cells called **gametes**, one from a **male** source and one from a **female** source.

Asexual reproduction

Before a cell divides, its nucleus divides. Each chromosome is copied, and each nucleus receives the same genetic material: genes, made of DNA.

As each cell divides into two, the resulting "daughter" cells are therefore exact copies of one another.

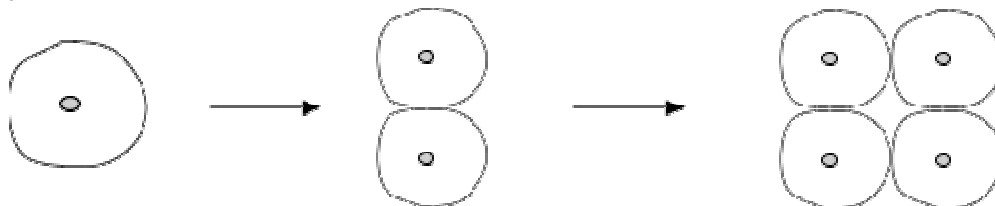

This process is responsible for the increase in number of cells which occurs during **normal growth and development**, and when tissues are replaced following injury.

Normal cell division is also the basis for **asexual reproduction**. Only one type of cell is involved, with

no input from another individual. Because no new genetic material is introduced, there is no variation in the resulting offspring.

Since the offspring from this process contain the same genetic material as one another (and the same as the original single parent), they can be described as a **clone**.

Examples of asexual reproduction

Asexual reproduction in plants



es c
Stenandrium which produces plantlets on stolons branching from buds in the parent plant. These are genetically identical and will grow to look alike, provided that they are raised in the same environment.

What features of the plant's environment would be need to be standardised (for them to look the same)?

Many plants used for food can be **propagated**, i.e increased in number, by the method of asexual reproduction.

Note: Do not confuse asexual reproduction with (sexual) reproduction in flowering plants, which often combine both male and female parts in the same flower.

Fruits and seeds are produced as a result of **sexual reproduction**.

Some parts of plants become enlarged as a result of normal cell division and this is called **vegetative growth**. This is often linked with surviving adverse weather conditions and keeping food reserves for the plant in order to grow again the next season. These plants are called **vegetables**, and Man often uses these reserves for himself.

Each of the examples of food plants below use asexual and sexual reproduction in different ways



Asexual reproduction in bacteria

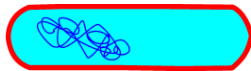

Bacteria reproduce asexually by a simpler process known as **binary fission**.

Asexual reproduction in animals



Asexual reproduction is much less common in animals, but it is often seen in simpler animals e.g. *Hydra*.

Identical twins are produced by a form of asexual reproduction when the ball of cells making up the embryo breaks into two, and each implants in the uterus and grows independently (after the normal sexual form of reproduction, obviously!)

In animal lifecycles, asexual reproduction sometimes alternates with sexual reproduction.

Sexual reproduction

Both male and female sex cells (sperms and eggs in animals, pollen and ovules in plants) are produced by a special cell division process which halves the number of chromosomes in each resulting cell. The chromosome separation process ensures that each sex cell has a **unique combination of genes** in its nucleus.

Fertilisation is also a **random process** and so when the nuclei fuse the resulting fertilised egg (zygote) has an individual genetic makeup.

In contrast to asexual reproduction, sexual reproduction introduces **variation** into offspring. This is an essential feature in order for **evolution** to take place.

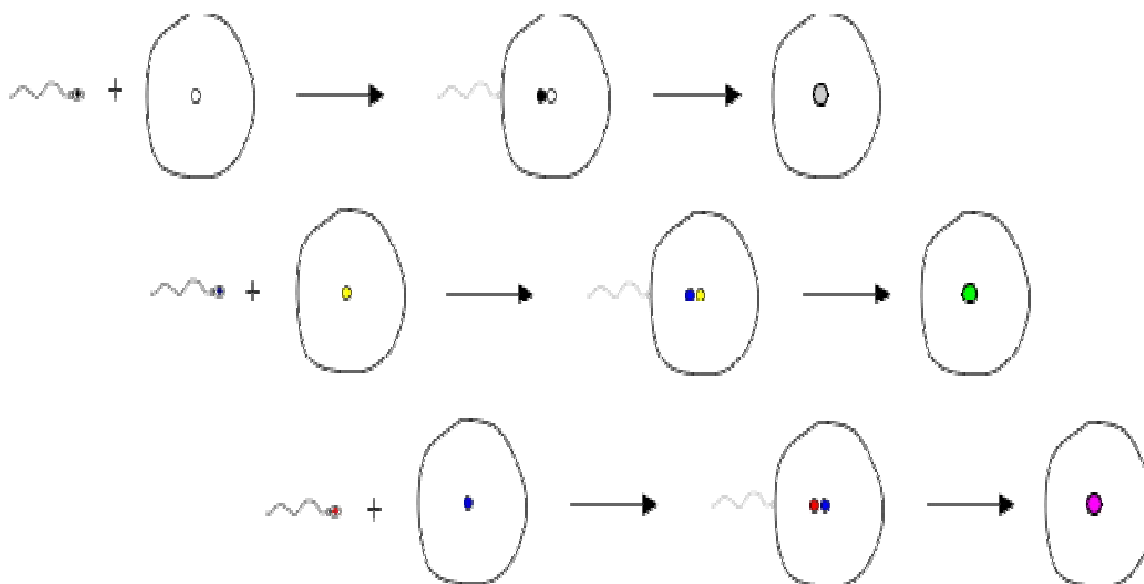

This zygote then divides again and again using the normal process of cell division, producing cells containing genes which are exact copies of the original. So each cell of the embryo, and the adult organism into which it develops, contains cells which are genetically identical. This is fortunate because the body's immune system will target any "foreign" cells (normally invading microbes) which differ from the others.

However as each organ develops, the cells within it (collectively known as tissues) become **specialised** for their particular tasks, e.g. muscle cells, nerve cells, red and white blood cells, and they "read" and use only part of their genetic information to do this.

As they have **differentiated** into these different cell types, it appears that they have lost the ability to divide again into other cell types. A few un specialised cells (e.g. stem cells) retain the ability to do this.

Summary of differences

	Asexual reproduction	Sexual reproduction
Number of parents	1 (either male or female)	2 (male and female)
Makeup of offspring	genetically identical (to parent and other offspring)	genetically different
Cell division process	normal cell division following nuclear division (by mitosis)	special cell division following nuclear division (by meiosis) producing sex cells (gametes): after fertilization subsequent divisions: normal
Advantages	quick - good for bulking up of numbers to colonise new areas	produces variation - the basis of evolution
Disadvantages	disease may affect all	slower - needs special processes to bring together gametes and protect zygote, embryo etc during development
Life cycle	useful when conditions	may be synchronised with (end of ?) growing

	ideal for growth	season
--	------------------	--------

Reference: http://www.bitopics.co.uk/genes1/asexual_and_sexual_reproduction.html

LECTURE 10 & 11

Sexual Reproduction in Plants

In sexual reproduction, a new individual is produced by the combining of material from two parents. In plants, as in animals, a **sperm** moves towards an **egg**. **Fertilization** occurs when the egg and sperm nuclei (the central part of each cell) unite to start development of the offspring. By repeated cell division, the fertilized egg grows from a single cell into a many-celled **embryo** (a tiny new plant that develops into a seed). All living things that reproduce sexually take some features from each parent. Next year's flowers will resemble this year's flowers because they inherit features from both of their parents.

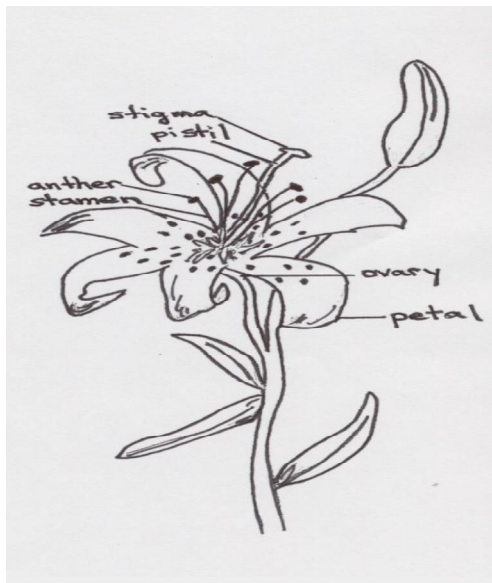

The **flower** is the reproductive organ in flowering plants possible. A wide variety exists in flower appearance, but the function of the flower parts is the same. Their functions are listed below.

The **stamen** – contains the male part of the flower. It produces **pollen**, a yellow powdery substance. Pollen is produced in the top of the stamen, in a structure called the **anther**.

The **pistil** – contains the female part of the flower. The top of the pistil is called the **stigma**. When a pollen grain reaches the pistil, it sticks to the surface of the stigma. The stigma produces a sugar that is used by the pollen to grow a tube. The **pollen tube** "digs" its way down through the style, allowing

delivery of the sperm down to the **ovary**. This is the enlarged part of the pistil where the female sex cells (eggs) are produced. The eggs are fertilized by the sperm from the pollen tube. The transfer of the pollen from anther to the stigma is called **pollination**. If allowed to develop without being picked, the ovary dries and splits open to disperse the seeds(s).

The **petals** – of the flower attract insects that carry the pollen from one plant to another. Some plants have no petals and the pollen is carried by the wind. Can you think of any other ways pollen could be transferred from plant to plant?

DEFINITION OF PLANT BREEDING

Plant breeding is the conscious human effort needed to improve and develop new plant varieties in order to satisfy the demand for human food and animal feed. It is a selection made possible by the existence of variability.

Plant breeding is an art or a science designed to bring about better high yielding, disease and insect resistant and adaptable crop genotypes through careful selection. It is an art because it involves the use of human power of observation and vision, i.e. ability to know the right time to carry out breeding operations and ability to know and identify crop genotypes that are, for example

- a. Physically resistance to disease and pests
- b. Agronomically good
- c. Easily cooked by the end users.

It is a science because we know already that plant physical characteristics(P) are controlled or conditioned by genotype(G) and environment(E) both of which can be manipulated by man.

$$P = G + E$$

Plant breeding is a science that relates to the study of genetics, cytology, pathology, entomology, pathology, systematic, statistics, biostatistics, physiology, biochemistry. It is therefore an applied science that involves all science disciplines.

SCOPE OF PLANT BREEDING

Plant breeding involves three major areas (plant introduction, hybridization and selection) that are referred to as conventional breeding methods.

Apart from the above, we have modern plant breeding methods which includes:

- a. Plant tissue culture
- b. Mutation breeding
- c. Plant engineering(biotechnology)

[A] PLANT INTRODUCTION

This is the oldest method/procedure of crop improvement. It involves movement of plants or crop species from one place to another, a conscious movement of crops from one area to new areas and as a result of this, we have centre of origin of crop and centre of diversification. For instance, Cocoa which was from South America was introduced into West Africa. Coconut from the Pacific Island is also common in West Africa. Maize is from Mexico and Pineapple is from Hawaii; Cowpea is from Ethiopia, Soybean is from China (Asia) and Banana is also from Asia.

It is therefore very possible that plant introduction can change the economy of a nation.

QUESTION: How can plant introduction change the economy of your Nation?

[B] HYBRIDIZATION

This is a process of making crosses between two plant parents that are genetically different (diverse, dissimilar, varied, and non-identical). Hybridization is called *controlled pollination*. It is divided into two major parts (a) out-crossing and (b) inbreeding.

OUT CROSSING

This is a relationship between individual plants that are genetically different. Here, two or more traits (characters) are combined in a new individual called **HYBRID**. The individual that are

genetically different can be called INBREED LINES. Hybrid is the product from the individual that are genetically dissimilar.

There are three types of hybrid:

- a. Single Cross (2 way) hybrid - AA x BB = AB
- b. Three(3) way hybrid - AA x BB x CC = AB x CC
- c. Double hybrid - (AA x BB) x (CC x DD) which is a product of two single hybrids.

A condition whereby the hybrid obtained from a cross is better than or superior to either of the two parents that are used in the cross is called **HYBRID VIGOUR**. Hybrid vigour is also referred to as **HETEROSIS**.

INBREEDING

This is a relationship among individuals that have common ancestors i.e. relationship among individuals that are genetically similar. It is a way of making crosses between individuals that are related by '**DESCENT**'. Note that Outcrossing increases the proportion of heterozygosity whereas Inbreeding increases homozygosity.

Consider a cross between a tall(TT) and a short(tt) plant parent

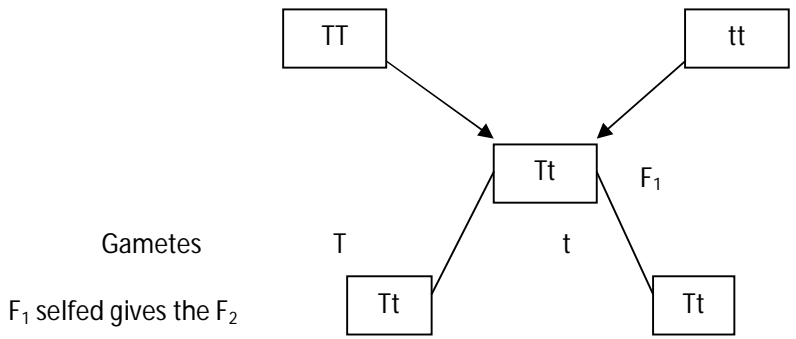

TT, Tt, Tt and tt are the F_2 gametes

At the F_1 generation, the proportion of heterozygosity is 100%. However, when you advance the generation heterozygosity becomes ½ and homozygosity is increased to 50% also. At the F_2 generation, the proportion of both heterozygosity and homozygosity is 50-50. Also in the F_3 generation, heterozygosity is 25% and homozygosity is 75%.

	HETEROZYGOSITY	HOMOZYGOSITY
F_1	100	0
F_2	50	50
F_3	25	75
F_4	12.5	87.5
F_5	6.25	93.75
F_6	3.125	96.875
F_7	1.56	98.435

As you advance the generations heterozygosity decreases whereas homozygosity increases. The proportion of homozygosity or heterozygosity allow breeders to know what it is called **COEFFICIENT OF INBREEDING (Q)** which measures the probability that 2 pairs of gene at a locus are descendants of a common ancestor. It is a measure of increases in homozygosity.

Inbreeding Coefficient = $2^m \left[\frac{1 - 1/2^n}{2^m} \right]$ OR $[1 - 1/2^m]^n$

Where n = Number of gene pairs and m = Number of generations of selfing

Worked Example 1

If $Q = ?$, $n = 2$ and $m = 3$

$$\begin{aligned} \text{Inbreeding Coefficient} &= \frac{2^3 - 1}{2^3} \\ &= \left[\frac{7}{8} \right] = 49/64 = 0.77 = 77\% \end{aligned}$$

Example 2 Find n when m is 2 and Q is 56.3%

Inbred lines are obtained from cross pollinated crops that are self pollinated after some generations of inbreeding i.e. they are lines that are self pollinated over a long generation. Consequently, after a long generation of inbreeding genotypic uniformity becomes greater than when it was at the initial population. A line that is obtained after some generations of inbreeding among cross pollinated population can be an inbred line. It is obtained from crossers that are self pollinating e.g. maize

Note: Inbreeds are never better than their parents, whereas hybrids are better than their respective parents. Therefore a hybrid is obtained by performing inbreeding on crossers that genetically differs for a number of generations. A pure line is the progeny of a single individual obtained by selfing or it is a product of self -fertilized homozygous individual because it is obtained from a selfer. Members of pure line individuals do not necessarily have the same genotype but their genetic uniformity is greater than what obtains in the progeny of cross fertilization.

CONSEQUENCES OF INBREEDING

1. Inbreeding increases homozygosity
2. It leads to reduction in quality of traits under consideration
3. It leads to production of inbred lines
4. It leads to exposure of deleterious recessive genes (albinism/old disease)
5. It leads to sterility of the ovary in plants
6. It leads to yellowing, stunting
7. It also leads to susceptibility to disease in plants.

[C] SELECTION: Means making a choice and it is done in plant breeding to allow individual plants to propagate themselves. Selection is possible only if there is variability and this suggests that variability makes selection possible and easy because bad characters can easily be seen and eliminated. One can equally select crop genotypes that are high yielding, disease resistance or agronomically good among others and then introduce or use them in hybridization with other crops from different environments. However, bad genotypes are left unselected. Therefore, selection acts on existing variability but it does not create variability.

Types of Selection

[A] MASS SELECTION. This is a selection based on the phenotypic value of a plant (Phenotype = Genotype + Environment). If the genotype is good and stable with little or no environmental effect, the genotype of an individual will be nearly equal its phenotype. It means that if a plant comes from a good parental background, environment may have little or no effect on it. Therefore for mass selection to be effective in a breeding programme environmental effect must be small.

Under mass selection harvested seeds or plants are bulked together (composited) without progeny testing. The objective here is to improve the general performance of the population by selecting and bulking superior genotypes. If the environment is good or favourable phenotype will be fantastic and there will be no change in genotype.

$$H = V_G/V_P = V_G/(V_G+V_E)$$

Thus, if V_E is very small or very close to zero, $H = V_G/V_P = 1 = 100\%$

Thus mass selection depends on the following:

1. Heritability of the character that we want to measure
2. The number of the genotypes selected (sample size)
3. Genotype by environment (GxE) interaction
4. Gene effect (either additive or dominant)

Sample size must be very large to avoid inbreeding especially when dealing with open pollinated crops because inbreeding depression leads to reduced vigour and yield. If the G x E interaction is high, phenotype is affected as a result of reduced heritability.

There are two types of heritability, we have *broad-sense* (H_B) and *narrow-sense* (H_N). The higher is the narrow-sense heritability the higher is the proportion of the characters that is transmitted from the parent to the offspring because it is additive portion (H_N) of the gene that is normally transmitted from one generation to another. This narrow-sense heritability is called the breeding value.

Problems of mass selection

1. Effect environment make mass selection ineffective
2. Until segregation occurs in later generation it is not possible to know whether your genotype is homozygote or heterozygote

$$\begin{aligned} \delta^2_p &= \delta^2_g + \delta^2_e \\ &= \delta^2_g + \delta^2_{gxe} + \delta^2_e \quad \text{because } P = G + E \text{ and thus,} \\ H_B &= \delta^2_g/\delta^2_p = \delta^2_g/(\delta^2_g + \delta^2_{gxe} + \delta^2_e) \end{aligned}$$

Example 1

If $\delta^2_e = 10$, $\delta^2_g = 5$ $H_B = 5/15 = 33\%$

Example 2

If $\delta^2_e = 20$, $\delta^2_g = 5$ $H_B = 5/25 = 1/5 = 10\%$

Advanced Formula

Where r = Number of replications = 3 , n = sample size = 6 , $\delta^2_e = 20$, $\delta^2_g = 5$ $\delta^2_{ge} = 15$

$$\begin{aligned} H_B &= \frac{\delta^2_g}{\delta^2_g + (\delta^2_e / r \times n) + (\delta^2_{ge} / r)} \\ H_B &= \frac{5}{5 + (10/18) + (15/3)} \\ &= 5/(5+0.7+5) = 5/10.7 = 0.49 = 49\% \end{aligned}$$

NOTE: When number of replicates increases environmental error decreases and heritability estimate increases

Example

If r = no. of rep. = 8 , n = sample size = 4
 $H_B = 5/(5 + 0.3 + 3.75) = 5/9.05 = 0.55 = 55\%$

NOTE: Stability of variety means general good performance of variety across environments. Adaptability means good performance of variety in one location e.g. Abeokuta. If $G \times E$ is large, heritability will be low. When there is no difference in the performance of genotypes in different environments, it means there is no $G \times E$ interaction.

[B] PURE LINE SELECTION

Pure line selection is a random selection of large number of single plants from original populations that are genetically diverse. Note that selection here is based on individual plants. It is the selected individual plants that becomes new varieties after given consideration to particular characteristics such as seed size, earliness, plant type, diseases resistance e.t.c If the original population is not diverse enough variability can not be created. For variability to be created therefore, we can make crosses or introduced new plants from another region.

Through pure line selection, homozygote plant populations can be obtained from single superior individuals. Thus, pure line selection is a breeding method used to develop grain crops like rice, barley, wheat, oat and a few selfers such as cowpea, soybean and tomato.

METHOD OF PURE LINE SELECTION

After plant introduction, selected plants are grown in progeny rows for easy observation. This is called progeny testing. Peculiar characteristics of interest are carefully observed and further selections are made for best lines, whereas the off-types (bad) lines are discarded. One can introduce disease *epiphytotics* or other aids to selection for easy elimination of undesirable plant types. Also, plants can be observed in different environments. The longer the period of observation the better is this type of selection. At the tail end, intensive observation and drastic reduction in number of lines is made to reduce cost. Thereafter, we have to isolate the best lines that were selected. The remaining lines after elimination are put in replicated trials to compare them with a commercially popular variety called "check" in relation to yield ability and distinct agronomic performance. Best lines are finally identified within 2 to 3 years.

Note that number of lines that are retained under mass selection is relatively larger than what obtains under pure line selection.

Inbreeding Coefficient

This is referred to as the proportion of homozygosity after a given number of generations of inbreeding.

If, for example the the number of generation of inbreeding(m) is 3 and the number of pairs of gene involved(n) is 2

$$\begin{aligned} \text{Inbreeding Coefficient (Q) is given as} &= [(2^m - 1)/2^m]^n = [(2^3 - 1)/2^3]^2 \\ &= [7/8]^2 \\ &= (0.875)^2 \\ &= 0.766 \end{aligned}$$

WHAT WILL BE THE VALUE OF Q IF M=2 AND N=2?

Progress from Selection:

This is the same as predicted gain, gain from selection or genetic advance. It is a measure of success during a selection process.

It is given as $G_s = K \delta H_B$ where

K = Selection differential (a constant) which can be calculated by knowing the difference between the mean of an original population(X_1) and the mean of a selected population(X_2) i.e. $K = X_1 - X_2$. The higher is the proportion of population retained; the lower is the "K" value. Theoretically, "K" values for 1,2,5,10,20,30% retained populations are 2.64,42,2.06,1.76,1.40,1.16, respectively.

Delta (δ) is phenotypic standard deviation of selected population usually at 5% selection.
 H_B represents the broad-sense heritability. Low H_B value means little or no gain from selection.

CONSIDER THE FOLLOWING WORKED EXAMPLE:

Days to first flowering in cowpea is the trait to be considered.

Day	Flowering days
1	30
2	29
3	35
4	25
5	40
6	30
7	21
8	30
9	40
10*	31

*

Mean days to first flower in TEN (10) plants = $30+29+35+25+40+30+21+30+40+31$
 $\Sigma x = 311$

Therefore, **mean of original population** X_1 is $311/10 = 31.1$

Variance $\delta^2 = \{\Sigma x^2 - [(\Sigma x)^2/n]\}/9$

$(\Sigma x)^2 = 96721$ i.e. $(311)^2$ and $(\Sigma x)^2/n = (\Sigma x)^2/10 = 96721/10 = 9672.1$
 $\Sigma x^2 = 9993$, $n = 10$ and $n-1 = 9$

X	30	29	35	25	40	30	21	30	40	31
X ²	900	841	1225	625	1600	900	441	900	1600	961

Thus, genetic variance (δ^2g) = $[9993.0 - 9672.1]/9 = 320.9/9 = 35.67$

IF THREE (3) plants with shortest days were selected from the population, population

Mean of selected population $X_2 = (20+25+21)/3 = 25$

Thus, $K = X_1 - X_2 = 31.1 - 25.0 = 6.1$

Assuming that error variance (δ^2e) = 10.2, and the calculated genetic $\delta^2g = 35.67$

The phenotypic variance (δ^2p) will be $\delta^2g + \delta^2e = 35.67 + 10.2 = 45.87$

Therefore, the phenotypic standard deviation = $\sqrt{\delta^2p} = \delta p = 6.77$

Consequently, $H_B = \delta^2g / \delta^2p = 36.67/45.87 = 79.94 \%$

Since $G_s = K^2 / \delta^2p$

LECTURE 12 & 13 $4 = 33.04$ days because G_s is expressed in the unit of the

Modern Breeding Methods

Apart from the conventional plant breeding, we also have non-conventional. These non-conventional methods are called Modern Breeding.

1. Plant Tissue Culture: This is the ability to raise a whole plant from a segment of mother plant e.g. a whole plant can be raised from small meristematic tissues (stem tip, root tip, leaves). When this one is done, such plant segment that are capable of been developed into a whole cultivated in a medium are said to be totipotent. Totipotency is a condition whereby a plant segment is cultured in a medium to develop into a whole plan. Plant tissue culture techniques helps in:
 - i. Rapid crop multiplication
 - ii. It is used in plant purification because disease and virus free plant segment can be removed for protoplast culture or adventurous apomixes
 - iii. Tissue culture is used to correct hybridization barriers such as male sterility and cross incompatibility through somatic hybridization.

Male sterility means the absence or non-functioning of the male part of a plant. It means pollen may be present and functionless or totally absent. Cross incompatibility is a condition whereby the pollen is fixed and present on the plant but the physiological barriers prevent fertilization such that seed cannot be produced.

2. Plant Engineering: Aspect of tissue culture technique used to transform a plant segment to improve another part of that plant. This is called surgery.
3. Mutation Breeding: This is used to bring about variability in apart from hybridization and introduction. It is a breeding method employed when all other methods have failed. One can induce mutation in plant. Genotypes by uv, Gamma rays (γ), x-rays, ultra-violent rays, chemical mutagene like formaldehyde, phenol, pyrimidine, nitrous acid. Note that many mutations are detrimental to their carries and disadvantageous to their carriers, such mutation can be eliminated by natural or artificial selection.
4. Apomixis: This is the reproduction and seed production that does not involve cross fertilization even in the presence of sex organs, this leads to vegetative propagation. It happens in crops like cassava, yam and flowers.

CONCEPT AND GENETIC BASIS OF BREEDING FOR DISEASE/INSECT RESISTANCE/TOLERANCE

- The breeding of disease- and insect- resistant organism has received more popular attention than any other phase of breeding because of the damage that diseases and insects can wreak on plants and animals.
- A healthy crop and livestock will help in increasing and stabilizing supplies of food and industrial raw materials.
- Several control methods have given effective control of disease and insect which include manipulation of agricultural practices (avoiding of monoculture, crop rotation, inter-cropping etc), biological control, chemical protection, however, where satisfactory disease resistant/tolerant individual are available, they are preferred over other means of control because they add little or nothing g to the cost of production. Also disease resistance is built into the plant and is there ready to provide protection.
- Breeding for disease- and insect- resistant/tolerant plants and animals will therefore be inevitable task.

Note:

- Resistance is the ability of the host to prevent any multiplication of products of the parasite – preventing the parasite from invading the organism and thriving on it
- Tolerance is another kind of genetic resistance. Some individual are susceptible to a pathogen which develops on them. However, these cultivars tolerate the attack without suffering a significant yield reduction.
- It is not a simple task to develop a cultivar resistant to several pathogenic species belonging to the same genus and it even more difficult to achieve resistance to pathogens from different genera. This is why the development of individual possessing tolerance to at least some pathogens in an important part of plant breeding.

For a successful planning of breeding programs designed to develop disease-resistant organism/individual it is important to note the following phenomena:

- ✓ Variations in the pathogenic capabilities of parasitic organisms i.e. parasites can differ in their pathogenicity
- ✓ Differences within host species in resistant to infectious disease i.e. organism differ in their ability to avoid disease – the host-pathogen relationship

SOURCES OF DISEASE RESISTANCE

- Breeding programs designed to produce resistant varieties must start with resistance-conferring genes. The resistance most useful in breeding is that found in varieties of the same species. When new diseases or races of established diseases appear, searching through the diversity of germplasm collections of varieties may provide success in locating adequate sources of resistance.
- In case adequate resistance does not appear to exist in cultivated species, then the breeder has two alternative sources to which he can turn for resistance.
 - Searching for resistance in related species or genera.
 - Inducing resistance through mutagenic substances.
- In breeding for disease resistance/tolerance it is important to be able to correlate genotype and phenotype. This is critical in breeding for disease resistance/tolerance because all genotypes are indistinguishable in the absence of the parasite. Therefore, programs of breeding for disease resistance/tolerance most involve the introduction of the causal organism to induce the symptoms that will allow genotypes conferring adequate resistance to be distinguished from susceptible genotypes.

Breeding for disease resistance/tolerance

- Any of the various methods of breeding appropriate for the crop in question can be used in developing disease or insect resistant varieties, once resistance-conferring genes have been found.
- When adequate resistance is not found in commercial lines, but only in types that cannot be used commercially because of their unsuitable agricultural properties, either the backcross or pedigree methods of breeding are usually selected.
- With either method one of the parents is chosen for its good characteristics, and the other parent is selected on the basis of demonstrated high level of resistance to a maximum number of races and minimum number of genes controlling resistance.
- If the resistant parent is a wholly un-adapted type, the backcross method is the logical choice as a breeding procedure.
- If, on the other hand, the breeder is satisfied that the resistant parent can also contribute to improved adaptation, quality, or productivity he may choose the pedigree or bulk methods of handling the segregating generations.