

**CHM 406:**

# Manufacture of some heavy inorganic chemicals:

## Top Inorganic Chemicals

### ✓ Sulphuric acid derivatives

- Sulphuric acid
- phosphoric acid
- Aluminum Sulfate

### ✓ Limestone derivatives

- Lime
- Sodium carbonate
- Sodium silicate

## ✓ **Inorganic Nitrogen compounds**

- Ammonia
- Nitric acid
- Ammonium nitrate
- Ammonium sulphate

## ✓ **Sodium Chloride Derivatives**

- Sodium hydroxide
- Chlorine
- Hydrochloric acid

## ✓ **Industrial Gases**

- Nitrogen
- Oxygen
- Carbon dioxide

## ✓ **Miscellaneous**

- Titanium dioxide
- Potash
- Carbon black

# Manufacture of some important inorganic chemicals

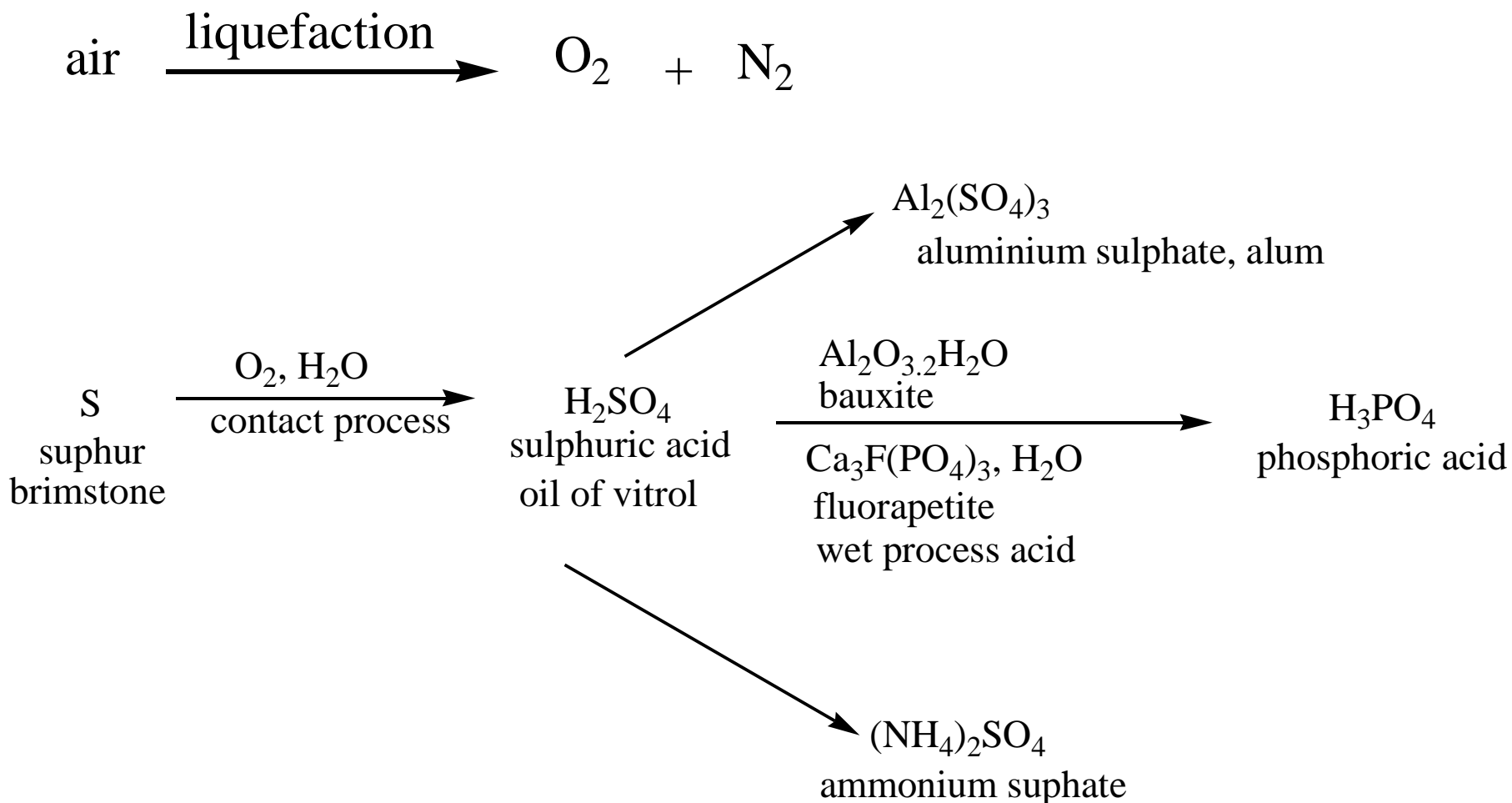

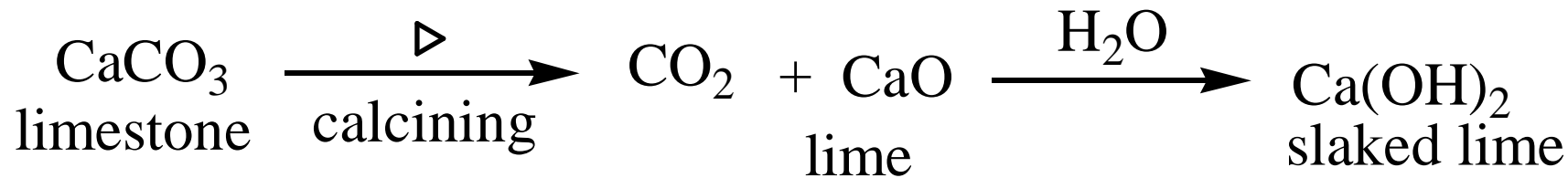
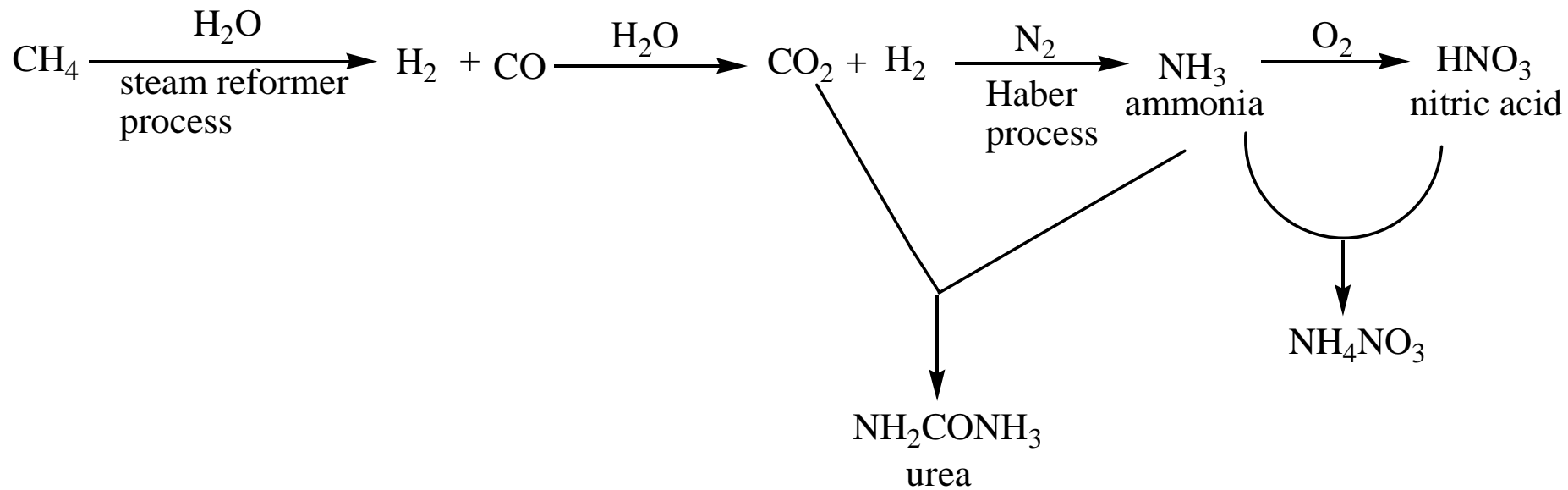

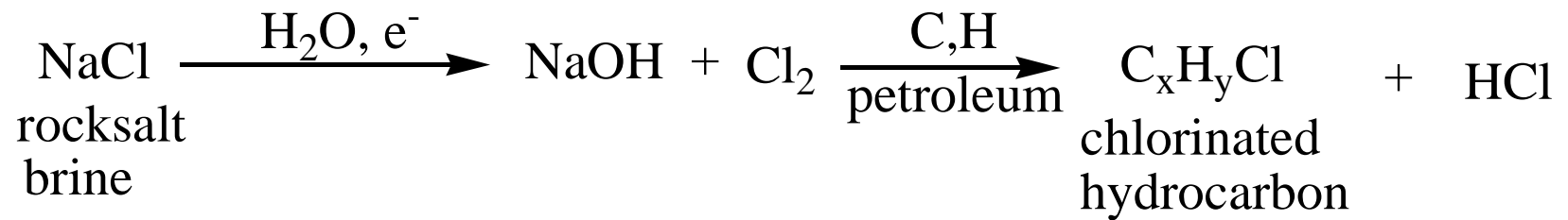
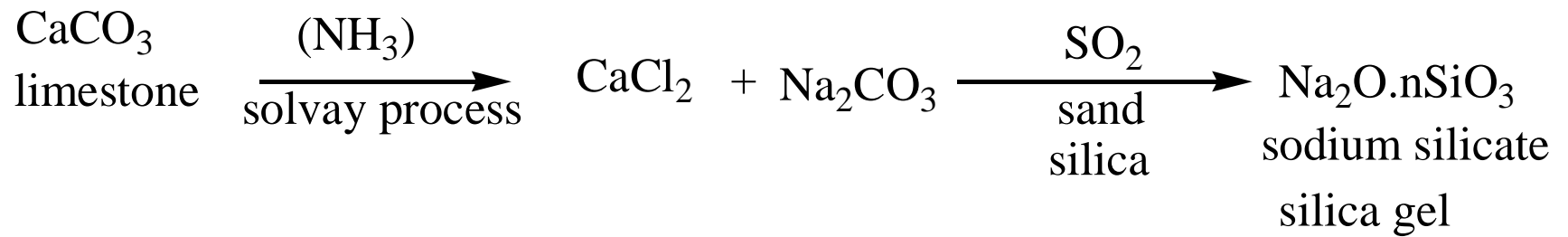

# Sulphuric acid ( $\text{H}_2\text{SO}_4$ )

- ✓ the largest volume chemical produced.
- ✓ It is normally manufactured at about twice the amount of any other chemicals.
- ✓ Since about 80% of all-sulfuric acid is made by the contact process which involves oxidation of sulfur, we will examine this raw material in detail.
- ✓ The average per capita consumption of sulfur in the United States is over 135 lb/yr.



- ✓ Elemental sulfur (brimstone) can be obtained by mining with the Frasch method, or by oxidation of hydrogen sulfide in the Claus process.
- ✓ Large deposits of sulfur along the Gulf Coast are released by heating the mineral with hot air and water under pressure (163°C, 250 psi) to make the yellow sulfur molten (mp 119°C) so that it is forced to the surface depth of 500-2500 ft.
- ✓ Alternatively, the Claus oxidation is performed hydrogen sulfide obtained from "sour" natural gas wells or petroleum crudes.
- ✓ The hydrogen sulfide, being acidic, is readily separated from the gas or oil by extraction with potassium carbonate or ethanolamine, acidifying, and heating to release the gas.

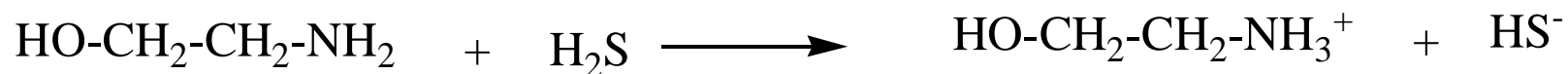

The hydrogen sulfide is then oxidized with air at 1000°C over a bauxite or alumina catalyst. The reactions taking place are given below.

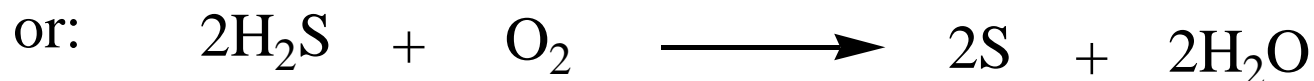
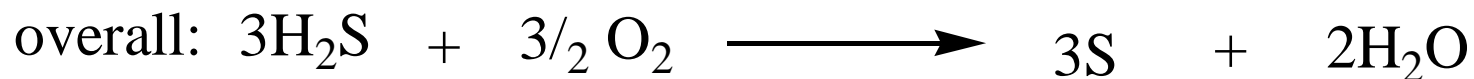
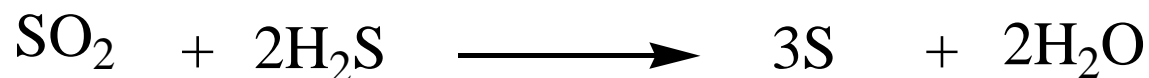

Approximately 90% of this sulphur is used to manufacture sulphuric acid.

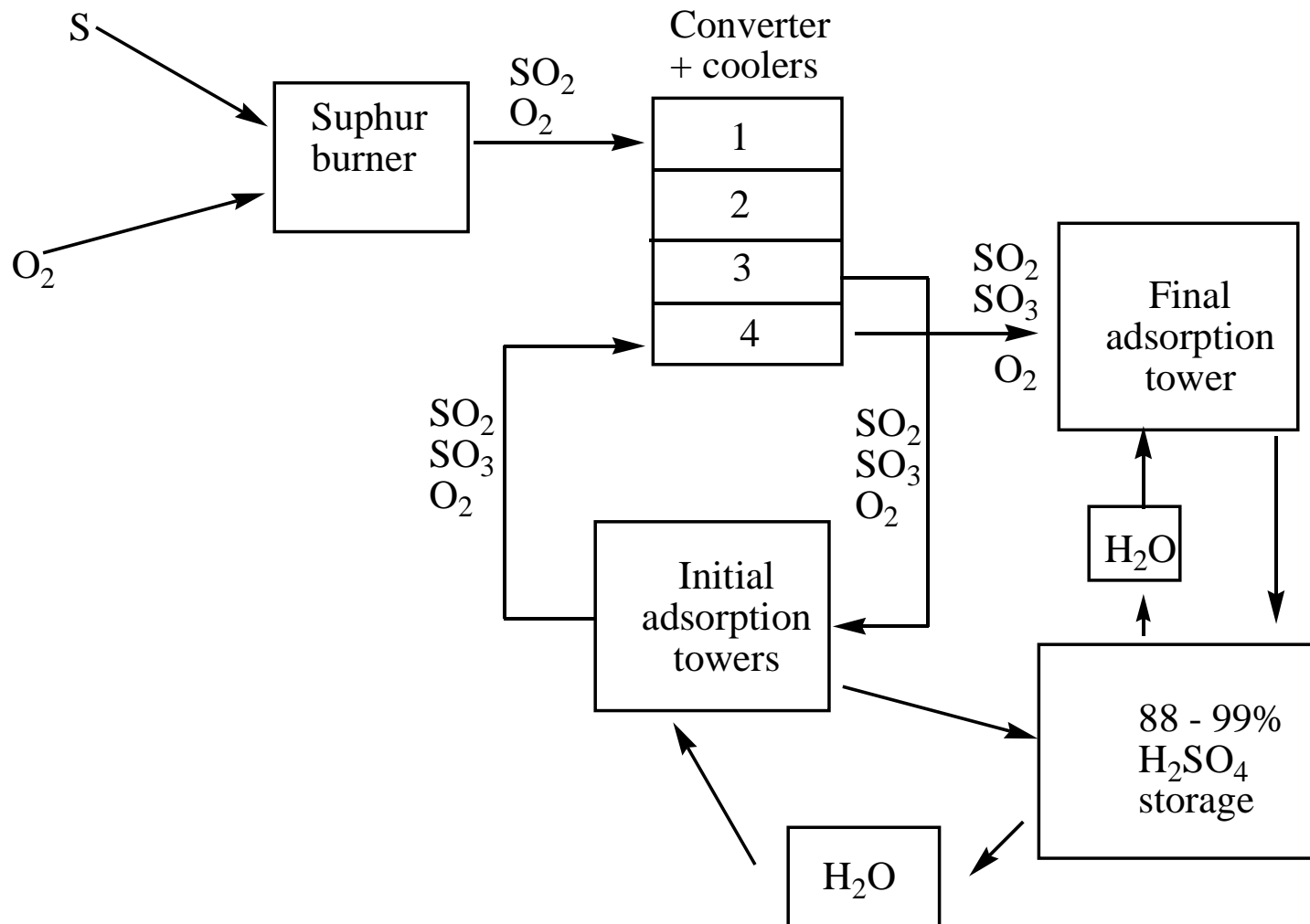

**Contact process for sulphuric acid  
manufacture (over 99 %)**

- ✓ Sulfur and oxygen are burned to  $\text{SO}_2$  (about 10%  $\text{SO}_2$  by volume) at  $1000^\circ\text{C}$  and then cooled to  $420^\circ\text{C}$ .
- ✓ The  $\text{SO}_2$  and  $420^\circ\text{C}$ , enter the converter, which contains four different chambers of  $\text{V}_2\text{O}_5$  catalyst.
- ✓ About 60 – 65%  $\text{SO}_2$  is converted to  $\text{SO}_3$  in the first layer with a 2-4 sec contact time.
- ✓ It is an exothermic reaction so the gas leaves at  $600^\circ\text{C}$ .
- ✓ It is cooled to  $400^\circ\text{C}$  with a heat exchanger and enters the second layer of catalyst.

- ✓ After the third layer about 95-96% of the  $\text{SO}_2$ , is converted into  $\text{SO}_3$ , near the limit of conversion unless  $\text{SO}_3$  is removed.
- ✓ The mixture is fed to the initial absorption tower, where  $\text{SO}_3$  is hydrated to  $\text{H}_2\text{SO}_4$  with a 0.5-1% rise in acid strength in the tower.
- ✓ The mixture is then repeated at 420°C and enters the fourth layer of catalyst, which gives overall a 99.7% conversion of  $\text{SO}_2$  to  $\text{SO}_3$ . It is cooled and then fed to the final absorption tower and hydrated to  $\text{H}_2\text{SO}_4$ .
- ✓ The final  $\text{H}_2\text{SO}_4$  concentration is 98-99% (1-2%  $\text{H}_2\text{O}$ ). A small amount of this is recycled by adding some water and recirculating into the towers to pick up more  $\text{SO}_3$ , but most of it goes to product storage.

- ✓ The  $V_2O_5$  catalyst has been the catalyst of choice since the 1920s. It is absorbed on an inert silicate support. It is not subject to poisoning and has about a 20-year lifetime.
- ✓ Many industrial processes are successes because the right catalyst was used. Around 70% of all industrial chemical conversions involve a catalyst.
- ✓ Although sulfur is the common starting raw material, other sources of  $SO_2$  can be used, including iron, copper, lead, nickel, and zinc sulfides. Hydrogen sulfide, a by-product of natural gas, can be burned to  $SO_2$ .
- ✓ Some countries use gypsum,  $CaSO_4$ , which is cheap and plentiful but needs high temperatures to be converted to  $SO_2$ ,  $O_2$  and  $H_2O$  and the  $SO_2$  recycled to make more  $H_2SO_4$ .
- ✓ About 5% of all  $H_2SO_4$  is recycled.

# H<sub>2</sub>SO<sub>4</sub>: Properties

- ✓ Anhydrous, 100% sulfuric acid is a colorless, odorless, heavy, oily liquid, at 338°C, where it decomposes by losing SO<sub>3</sub> to give 98.3% H<sub>2</sub>SO<sub>4</sub>.
- ✓ It is soluble in all ratios with water. This dissolution in water is very exothermic.
- ✓ It is corrosive to the skin and is a strong oxidizing and dehydrating agent.
- ✓ Common concentrations and names are battery acid, 33.5% H<sub>2</sub>SO<sub>4</sub>; chamber or fertilizer acid, 62.18%; tower or Glover acid, 77.67%; and reagent, 98%.

- ✓ Oleum is also manufactured. This is excess  $\text{SO}_3$  dissolved in  $\text{H}_2\text{SO}_4$ . For example, 20% oleum is 20%  $\text{SO}_3$  in 80%  $\text{H}_2\text{SO}_4$  (no  $\text{H}_2\text{O}$ ).
- ✓ Sulfuric acid comes in different grades: technical, which is colored and contains impurities but which can be used to make fertilizer, steel, and bulk chemicals; certified pure (CP); and U.S. Pharmacopeia (USP). The last two are used to make batteries, rayon, dyes, and drugs.
- ✓ Rubber or lead-lined containers can be used for dilute acid; iron, steel, or glass can be used for concentrated acid.



# CEMENT AND BUILDING MATERIALS

In spite of the modern concrete roads and buildings everywhere around us, it is difficult to realize tremendous growth of the cement industry during the past century. Humans had early discovered certain natural rocks which, through simple calcination, gave a product that hardened on the addition of water. Yet the real advance did not take place until physicochemical studies and chemical engineering laid the basis for the modern efficient plants working under closely controlled conditions with a variety of raw materials.

Cement dates back to the antiquity, and one can only speculate as to its discovery. A cement was used by the Egyptian in constructing the Pyramids. The Greeks and Romans used volcanic tuff mixed with lime for cement, and a number of these structures are still standing. In 1824 an Englishman, Joseph Aspdin, patented an artificial cement made by the calcination of an argillaceous limestone. He called this *portland* because concrete made from it resembled a famous building stone obtained from the Isle of Portland near England. This was the start of the Portland cement industry as we know it today. The hard clinkers resulting from burning a mixture of clay and limestone or similar materials is known by the term Portland cement to distinguish it from natural, pozzolan and other cements.

# TYPES OF CEMENTS

There are various types of cements:

- **1. Portland cement**

- *Portland cement* can be defined as the product obtained by pulverizing clinker consisting essentially of hydraulic calcium silicates, to which no additions have been made subsequent to calcination other than water and or untreated calcium sulfate, except that additions not exceed 1.0% of other materials may be interground with the clinker at the option of the manufacturer. Different types of Portland cement which contains varying amount of clinker compounds are available.

Formula	Name	Abbreviation
$2\text{CaO} \cdot \text{SiO}_2$	Dicalcium silicate	$\text{C}_2\text{S}$
$3\text{CaO} \cdot \text{SiO}_2$ <i>Clinker compounds</i>	Tricalcium silicate	$\text{C}_3\text{S}$
$3\text{CaO} \cdot \text{Al}_2\text{O}_3$	Tricalcium aluminate	$\text{C}_3\text{A}$
$4\text{CaO} \cdot \text{Al}_2\text{O}_3 \cdot \text{Fe}_2\text{O}_3$	Tetracalcium aluminoferrite	$\text{C}_4\text{AF}$
$\text{MgO}$	Magnesium oxide in free state	$\text{MgO}$

- **Type I:** *Regular portland cements* are the usual products for general concrete construction. There are other types of this cement such as white, which contains less ferric oxide, oil-well cement, quick-setting cement, and others for special uses.
- **Type II:** *Moderate-heat-of-hardening and sulfate-resisting portland cements* are for use where moderate heat of hydration is required or for general concrete construction exposed to moderate sulfate action. The heat evolved from these cements should not exceed 70 and 80 cal/g after 7 and 28 days, respectively.

- **Type III:** *High-early-strength (HES) cements* are made from raw materials with a lime-to-silica ratio higher than that of Type I cement and are ground finer than Type I cements. They contain a higher proportion of tricalcium silicate ( $\text{Ca}_3\text{S}$ ) than regular portland cements. This, with the finer grinding, causes quicker hardening and a faster evolution of heat. Roads constructed from HES cement can be put into service sooner than roads constructed from regular cement.

- **Type IV:** *Low-heat portland cements* contain a lower percentage of  $C_3S$  and tricalcium aluminate ( $C_3A$ ), thus lowering the heat evolution. Consequently, the percentage of tetracalcium aluminoferrite ( $C_4AF$ ) is increased because of the addition of  $Fe_2O_3$  to reduce the amount of  $C_3A$ . Actually, the heat evolved should not exceed 60 and 70 cal/g after 7 and 28 days, respectively and is 15 to 35% less than the heat of hydration of regular or HES cements.

- **Type V:** *Sulfate resisting portland* cements are those which, by their composition or processing, resist sulfates better than the other four types. Type V is used when high sulfate resistance is required. These cements are lower in  $C_3A$  than regular cements. In consequence of this, the  $C_4AF$  content is higher.



- ***Mansory cements*** are commonly finely ground mixtures of portland cement, limestone, and air-entraining agents. Some (also based on portland cement) contain hydrated limes, diatomaceous earth, and small additions of calcium stearate, petroleum, or high-colloidal clays.
- ***Air entrainment***: The use of air-entrainment agents (minute quantities of resinous materials, tallows, and greases) is important. These agents increase the resistance of the hardened concrete to scaling from alternate freezing and thawing and the use of de-icers (such as  $\text{CaCl}_2$ ).

- **Pozzolan cement**
- Since the beginning of the Christian era the Italians have successfully employed pozzolan cement, made by grinding 2 to 4 parts of a pozzolan with 1 part of hydrated lime. A pozzolan is a material which is not cementitious in itself but which becomes so upon admixture with lime. Natural pozzolans are volcanic tuffs; an artificial one of prominence is fly ash.

- **3. High-alumina cement**
- Essentially a calcium aluminate cement, is manufactured by fusing a mixture of limestone and bauxite, the latter usually containing iron oxide, silica, magnesia, and other impurities. It is characterized by a very rapid rate of development of strength and superior resistance to sea water and sulfate bearing water.

- **4. Special, or corrosion-resisting cements and mortars**
- These are used in large quantities for the fabrication of corrosion proof linings for chemical equipment such as brick-lined reactors, storage tanks, absorption towers, fume ducts and stacks, pickling tanks, floors, sumps, trenches, and acid digesters, to name but a few. Many kinds of special cements are available such as Furan, phenolic, sulfur, silicate cements are the most important.

- **5. Controlled cement**

- Controlled cement, introduced by Permanente cement and Medusa is use to prevent shrinking and cracking upon setting. By combining 10 to 20% calcium sulfoaluminate (from bauxite, gypsum, and limestone) with portland cement, the tendency of concrete to crack or shrink can be eliminated.

- **Raw Materials for Portland Cement**
- Portland cement is made by mixing and calcining calcareous and argillaceous materials in the proper ratio. The raw materials used for manufacturing of portland cements include: cement rock, lime stone, Marl, Clay and Shale, Blast-furnace slag, Gypsum, Sand and sandstone, Iron materials, etc.

- Formerly, a large amount of cement was burned from argillaceous limestone, known as cement rock, found in Leigh district of Pennsylvania and New Jersey. This material was first used as a natural cement and when found deficient in lime, was corrected by adding a small proportion of limestone. In addition to natural materials, some plants use artificial products such as blast-furnance slag and precipitated calcium carbonate obtained as a by-product in the alkali and synthetic ammonium industry. Sand, waste bauxite, and iron ore are sometimes consumed in small amounts to adjust composition of the mix. Gypsum (4 to 5%) is added to regulate the setting time of the cement.

- **MANUFACTURING PROCEDURE: *The Wet And Dry Processes.***

- In both *wet* and *dry* processes, closed circuit grinding is preferred to open-circuit grinding in preparing the raw materials because in the former the fines are passed on and the coarse material returned, whereas in the latter the raw material is ground continuously until its mean fineness has reached the desired value. The wet process, though the original one, is being displaced by the dry process, especially for new plants, because of the saving in heat, accurate control, and mixing of the raw mixtures it affords.



- In the *wet process* the solid material, after dry crushing, is reduced to a fine state of division in wet tube or ball mills, and passes as a slurry through bowl classifier or screens. The slurry is pumped to correcting tanks, where rotating arms make the mixture homogenous and allow the final adjustment in composition to be made. In some plants, this slurry is filtered in a continuous rotary filter and fed into the kiln.

- The *dry process* is especially applicable to natural cement rock and to mixtures of limestone and clay, shale, or slate. In this process the materials may be roughly crushed, passed through gyratory and hammer mills, dried, sized, and more finely ground in tube mills, followed by air separators. Before entering the kiln a thorough mixing and blending by air or otherwise takes place. This dry, powdered material is fed directly to rotary kilns, where the chemical reactions take place. Heat is provided by burning oil, gas, or pulverized coal, using preheated air from cooling the clinker. Efficient air pollution control equipment such as baghouses or electrostatic precipitation are now required for kilns.

- **Setting and hardening of cement**

- Although many theories have been proposed to explain the setting and hardening of cement, it is generally agreed that *hydration* and *hydrolysis* are involved. The hydration products have very low solubility in water. If this were not true, concrete in contact with water would be rapidly attacked. In recent years much attention has been given to the heat evolved during the hydration of cement. The various compounds contribute to the heat of hardening (g/g) as follows:

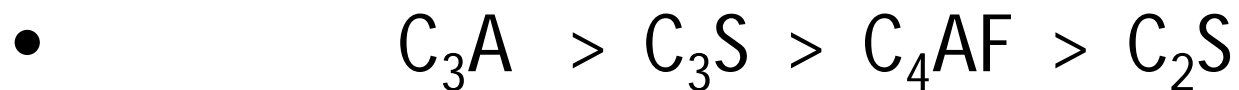

Low-heat-of-setting cement are usually used in the construction of dams to avoid cracking the structure from heat stresses during setting and cooling. As an additional safe-guide, the structure can be cooled during setting by circulating cold water through the concrete mass. Concrete based on cement is broadening in application and increasing in quantity each year. Such concrete includes low-heat-of-hardening, quick or retarded hardening, low and high density, prestressed concrete beams for greater strength and to save steel.

- **Special cements**

- For many corrosive conditions Portland cement is unsuitable or not economical. Hence many special types of cement have been developed, of which many types are industrially important. There are special cements based on organic plastics generally known as Adhesives. Sulfur cements are also available commercially as simple mixtures of fillers, and since 1930 as homogenous plasticized filled sulfur ingots possessing low coefficients of expansion. Sulfur cements are resistant to nonoxidising acids and salts but should not be used in the presence of alkalies, oils, greases, or solvents. The crystalline change in sulfur structure at 200°F limits their use. Thiokol-plasticized, silica-filled sulfur cements have been accepted as a standard material for joining bricks, tile, and cast-iron pipe.

- Silica-filled chemically setting silicate cements withstand a higher temperature (1000°F) than the preceding cements. Usually 2 parts by weight of finely divided silica powder is used to 1 part of sodium silicate. Silicate cements are resistant to all concentrations of inorganic acids except hydrofluoric. Silicate cements are not suitable at pH values above 7 or in the presence of crystal-forming systems. Two typical applications are the joining of bricks in chromic acid reaction tanks and in alum tanks.

# Industrial gases

These includes:

- ✓ Nitrogen
- ✓ Oxygen
- ✓ Carbon dioxide
- ✓ Hydrogen

# Nitrogen: Manufacture

- ✓ The large-scale availability of nitrogen, oxygen, and argon from liquefaction of air began about 1939-40.
- ✓ A 90% recovery is now feasible for these three major components in air.
- ✓ Nitrogen makes, up 78% of all air, oxygen 21%, and argon 0.9%.
- ✓ Two major processes are used, differing only in the way in which the expansion of air occurs.



- ✓ The Linde-Frankl cycle is based on the classic Joule-Thompson effect of a gas, which means that there is a tremendous cooling effect of a gas when it is rapidly expanded, even though no external work is done on the system.
- ✓ Alternatively, the Claude process employs an expansion engine doing useful work on the gas.
- ✓ The temperature is reduced because of removal of energy.
- ✓ This process is more efficient than relying on the Joule-Thomson effect.



# Liquefaction of air

- ✓ Air is filtered to remove particulates and then compressed to 77 psi.
- ✓ An oxidation chamber converts traces of hydrocarbons into  $\text{CO}_2$  and  $\text{H}_2\text{O}$ .
- ✓ The air is then passed through a water separator, which gets some of the water out.
- ✓ A heat exchanger cools the sample down to very low temperatures, causing solid water and carbon dioxide to be separated from the main component.

- ✓ Most of the  $\text{N}_2 - \text{O}_2$  mixture, now at  $-168^\circ\text{C}$  and 72 psi enters the bottom of fractionating column.
- ✓ An expansion valve at this point causes further cooling.
- ✓ The more volatile nitrogen rises to the top of the column as a gas since nitrogen (bp =  $-196^\circ\text{C}$ , 77K) has a lower boiling point than oxygen (bp =  $-183^\circ\text{C}$ , 90°K), and the column at 83°K is able to separate the two.
- ✓ The oxygen stays at the bottom of the column as a liquid because it is less volatile.

- ✓ A small amount of  $N_2 - O_2$  after being recooled in the heat exchanger is shunted to the main expander valve (operated by the Joule-Thompson effect or by a Claude engine).
- ✓ The extremely cold gas is recycled into the heat exchanger to keep the system cold.
- ✓ Some argon remains in the oxygen fraction and this mixture can be sold as 90 – 95% oxygen.
- ✓ If purer  $O_2$  is required, a more elaborate fractionating column with a greater number of plates gives an  $O_2 - Ar$  separation.
- ✓  $O_2$  can be obtained in 99.5% purity in this fashion.

- ✓ Argon can be obtained in from a middle fraction between nitrogen and oxygen and redistilled.
- ✓ A small amount of hydrogen can be added to react with any remaining O<sub>2</sub> to give O<sub>2</sub>-free argon.
- ✓ Not only Argon, but other rare gases; neon, krypton, and xenon, can also be obtained in the separation.

# Uses of Nitrogen

- ✓ The largest use of nitrogen is in ammonia synthesis
- ✓ Chemicals manufactured with nitrogen include many reactions where nitrogen is the inert blanketing atmosphere to prevent reaction with oxygen and minimize the possibility of fire and explosion for reactions sensitive to oxygen.
- ✓ Oil and gas extraction is a fast-growing use of nitrogen. This application is called advanced oil recovery (AOR) or enhanced oil recovery (FOR), where nitrogen maintains pressure in oil fields so that a vacuum is not formed underground when natural gas and oil are pumped out. It competes with carbon dioxide in this application.

- ✓ In the electronic- industry, nitrogen is an important blanketing and purge gas in the manufacture of semiconductors and integrated circuits. It is used in liquid form for cryogenic (low temperature) testing.
- ✓ In primary metals manufacture it is an inert atmosphere for making steel, blanketing the powdered coal and other fuel for-the furnace.
- ✓ Petroleum refining makes use of it for its inert atmosphere and the food industry uses liquid nitrogen for freezing.



# OXYGEN

- ✓ The manufacture of oxygen is described along with that of nitrogen. Both are formed from the liquefaction of air.
- ✓ Oxygen gas is colorless, odourless, and tasteless, but it is slightly blue in the liquid state.
- ✓ Up to 99.5% purity is available commercially.
- ✓ It is commonly used from seamless steel cylinder under 2,000 psi pressure.
- ✓ The steel industry and other primary metal production prefers to use pure oxygen rather than air in processing iron.

- ✓  $O_2$  also removes S, P, Si, and other impurities in iron.
- ✓ The steel industry uses approximately half of all oxygen, the production of oxygen is very dependent on this one use.
- ✓ Gasification involves partial oxidation of hydrocarbons to produce synthesis gas, a mixture of carbon monoxide and hydrogen.
- ✓ Chemicals made from- oxygen include ethylene and propylene oxide, titanium dioxide, acetylene, vinyl chloride, and vinyl acetate.
- ✓ Welding and cutting with an oxygen-acetylene torch is common in industry.
- ✓ The health sciences use oxygen to ease patients' breathing.
- ✓ Pulp and paper bleaching and sewage treatment and aeration are other examples of oxygen's broad importance to many industries that affect our everyday lives.

# HYDROGEN

- ✓ A variety of low molecular weight hydrocarbons can be used as feedstock in the steam-reforming process.
- ✓ Equations are given for both methane (natural gas) and propane.
- ✓ The reaction occurs in two separate steps: reforming and shift conversion

### Methane

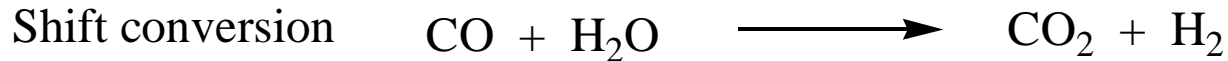

### Propane

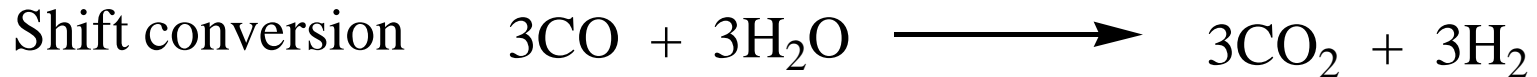
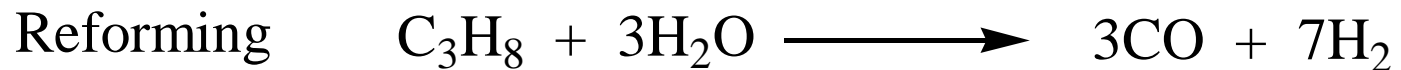

**The reforming step makes a hydrogen : carbon monoxide mixture that is one of the most important materials known in the chemical industry.**

**It is called **synthesis gas** and is used to produce a variety of other chemicals.**

- ✓ The old method of making synthesis gas was from coke but this gave a lower percentage of hydrogen in the mixture, which was called water gas or blue gas.



- ✓ Higher H<sub>2</sub> : CO ratios are now needed, and thus the newer hydrocarbon feedstocks are used. Coal gives a 1:1 ratio of H<sub>2</sub>:CO, oil a 2:1 ratio, gasoline 2.4:1, and methane 4:1.

# CARBON DIOXIDE

Steam reforming process:

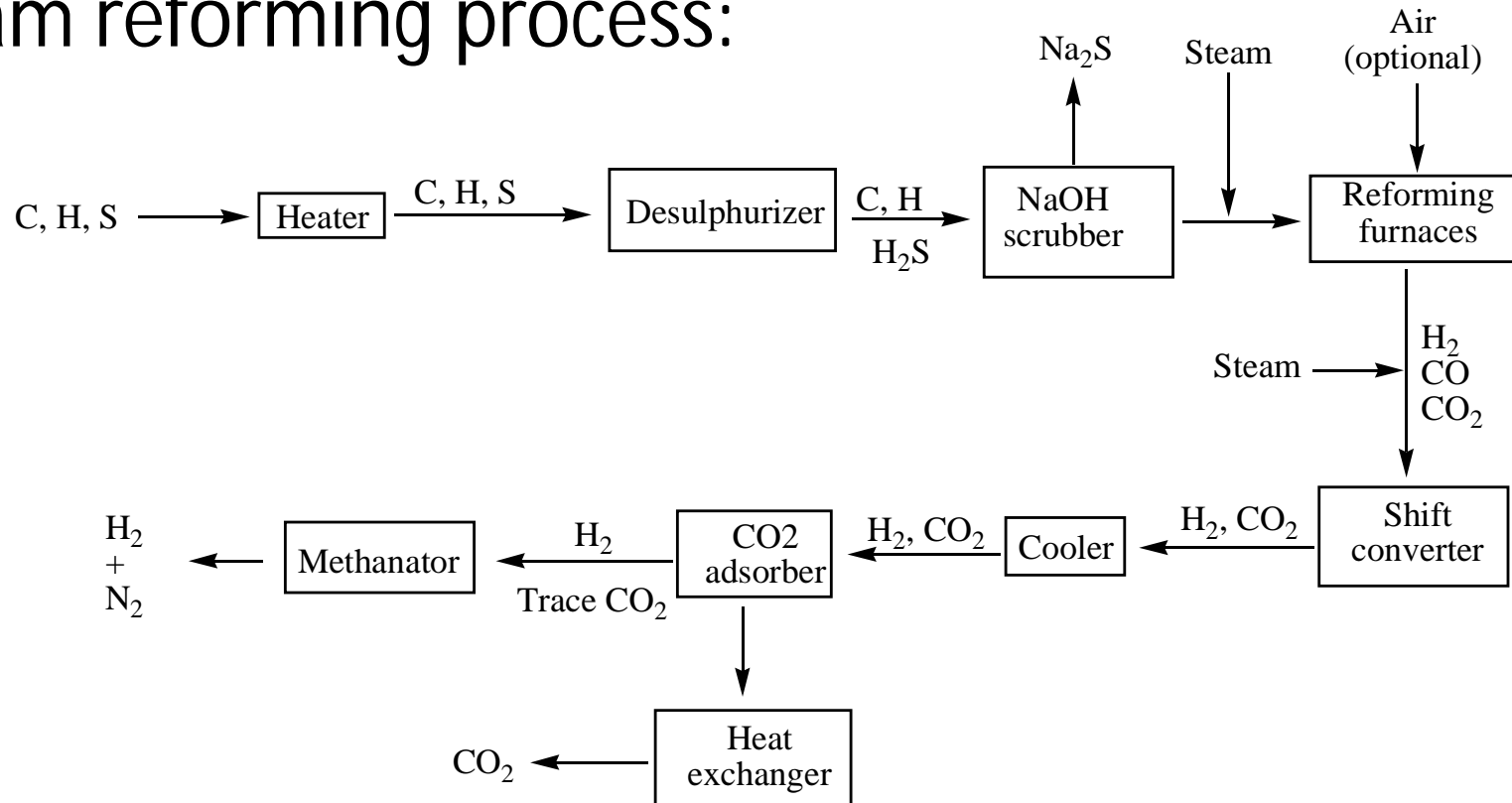

Steam-reforming of hydrocarbons.

- ✓ The hydrocarbon feedstock, usually contaminated with some organosulfur traces, is heated to 370°C before entering the desulfurizer, which contains a metallic oxide catalyst that converts the organosulfur compounds to hydrogen sulfide.
- ✓ Elemental sulfur can also be removed with activated carbon absorption.
- ✓ A caustic soda scrubber removes the hydrogen sulfide by salt formation in the basic aqueous solution.



- ✓ Steam is added and the mixture is heated in the furnace at 760-980°C and 600psi over a nickel catalyst. When larger hydrocarbons are the feedstock, potassium oxide is used along with nickel to avoid larger amounts of carbon formation.
- ✓ Air can be added to the secondary reformers.
- ✓ Oxygen reacts with some of the hydrocarbon feedstock to keep the temperature high.
- ✓ The nitrogen of the air is utilized when it, along with the hydrogen formed, reacts in the ammonia synthesizer.
- ✓ More steam is added and the mixture enters the shift converter, where iron or chromic oxide catalysts at 425°C further react the gas to hydrogen and carbon dioxide.
- ✓ Some shift converters have high and low temperature sections.



**CHM 406**

**Inorganic Nitrogenous  
Compounds**

# Ammonia $\text{NH}_3$

- ✓ Ammonia is in the top 10 chemicals and some important ammonia derivatives are:
- ✓ ammonium nitrate, nitric acid, urea, and ammonium sulfate.
- ✓ Most ammonia eventually ends up in fertilizers of one type or another.
- ✓ The manufacturing chemistry for these chemicals is outlined below:

- $\text{N}_2 + 3\text{H}_2 \rightleftharpoons 2\text{NH}_3$  ammonia
- $\text{NH}_3 + 2\text{O}_2 \longrightarrow \text{HNO}_3 + \text{H}_2\text{O}$   
nitric acid
- $\text{NH}_3 + \text{HNO}_3 \longrightarrow \text{NH}_4\text{NO}_3$   
ammonium nitrate
- $2\text{NH}_3 + \text{CO}_2 \longrightarrow \text{NH}_2\text{CONH}_2 + \text{H}_2\text{O}$   
urea
- $2\text{NH}_3 + \text{H}_2\text{SO}_4 \longrightarrow (\text{NH}_4)_2\text{SO}_4$   
ammonium sulfate

# Manufacture of Ammonia

- About 90% of Ammonia generate hydrogen by steam-reforming of natural gas.
- If the hydrogen is made by steam-reforming, air is introduced at the secondary reformer stage. This provide  $N_2$  for the ammonia reaction.
- The  $O_2$  of the air reacts with the hydrocarbon feedstock in combustion and helps to elevate the temperature of the reformer. Otherwise  $N_2$  can be added from liquefaction of air.
- In either case, a  $H_2 - N_2$  mixture is furnished for ammonia manufacture.

# Haber process for making ammonia

## Reaction

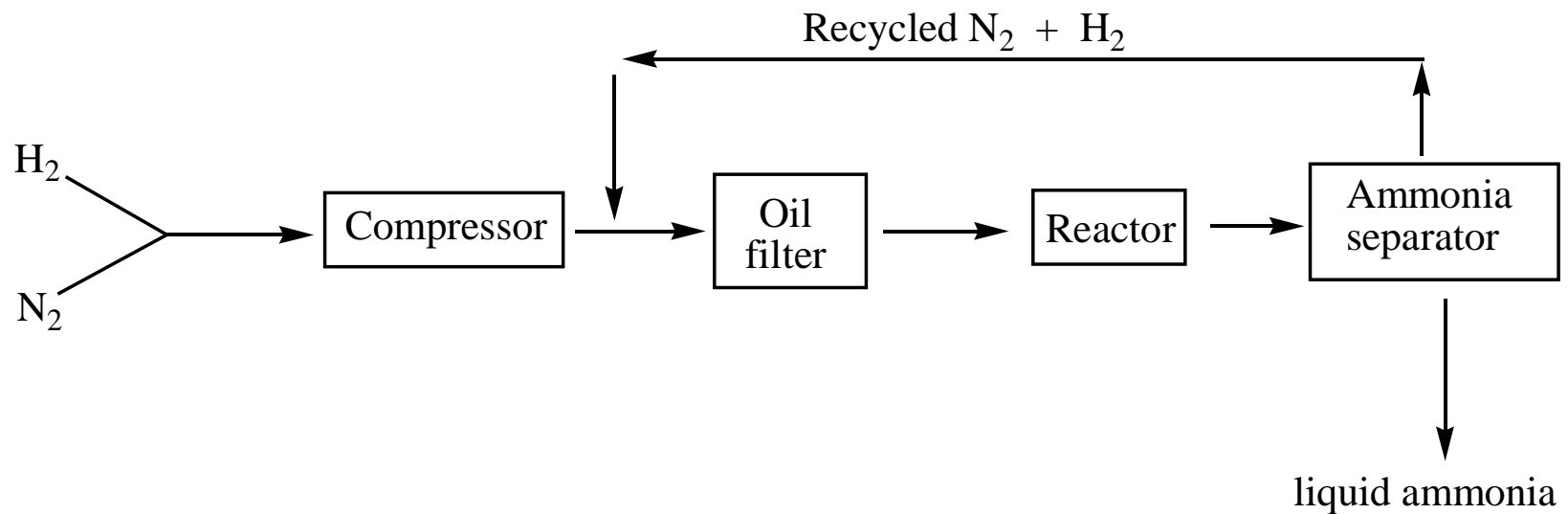
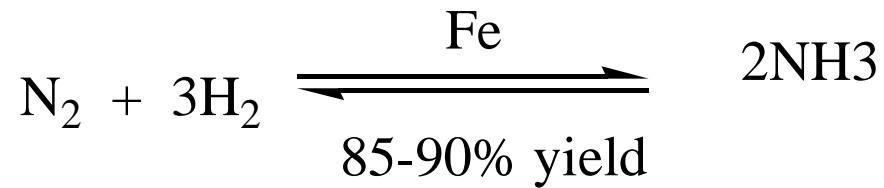

## Description of Haber process

- The reaction of  $N_2$  and  $H_2$  gases was first studied by Haber with Nernst and Bosch in 1904 – 1916.
- The two gases were adjusted to a 3:1  $H_2:N_2$  mixture and compressed to 2000 – 10,000 psi (150-600atm).
- The mixture is filtered to remove traces of oil, joined to recycled gases, and is fed to the reactor at 400-600°C.

- The reactor contains an iron oxide catalyst that reduces to a porous iron metal in the  $H_2:N_2$  mixture.
- Ruthenium on carbon is a new catalyst and is much more active than iron, but also more expensive.
- Exit gases are cooled to  $-10$  or  $-20^\circ C$  and part of the ammonia liquefies.
- The remaining gases are recycled. The conversion of ammonia is 20-22%. The overall yield is 85-90%.

# Properties of ammonia

- ❖ Anhydrous ammonia is a colourless gas with a pungent odour, bp  $-33^{\circ}\text{C}$ .
- ❖ It can be liquefied at  $25^{\circ}\text{C}$  under 175 psi.
- ❖ The gas is usually shipped as a liquid under pressure.
- ❖ It is very soluble in water. The water solution can be called ammonia water, aqua ammonia, ammonium hydroxide.



# Uses of ammonia

- It can be applied directly for fertilizer or made into other nitrogen-containing compounds used for fertilizer such as urea, ammonium nitrate, ammonium phosphate, ammonium sulfate, and nitric acid.
- Overall about 80% of ammonia has an end use as fertilizer.
- Explosive, a second important end use, made from ammonia are ammonium nitrate and, via nitric acid, the nitroglycerin used in dynamite.
- Chemical intermediates include acrylonitrile and caprolactam which eventually go into fibers.